

National Testing Agency

Question Paper Name :	B ARCH 5th Aug 2021 Shift 2
Subject Name :	B ARCH
Creation Date :	2021-08-05 19:19:56
Duration :	180
Total Marks :	400
Display Marks:	Yes

B ARCH

Group Number :	1
Group Id :	67603327
Group Maximum Duration :	0
Group Minimum Duration :	180
Show Attended Group? :	No
Edit Attended Group? :	No
Break time :	0
Group Marks :	400
Is this Group for Examiner? :	No

Mathematics Section A

Section Id :	676033152
Section Number :	1
Section type :	Online
Mandatory or Optional :	Mandatory
Number of Questions :	20
Number of Questions to be attempted :	20
Section Marks :	80

Enable Mark as Answered Mark for Review and Clear Response : Yes
Sub-Section Number : 1
Sub-Section Id : 676033152
Question Shuffling Allowed : Yes

Question Number : 1 Question Id : 6760332365 Question Type : MCQ Option Shuffling : Yes Is Question Mandatory : No
Correct Marks : 4 Wrong Marks : 1

The value of the integral $\int_3^5 x\sqrt{(8-x)} dx$ is

Options :

6760337281. $\frac{50\sqrt{5}}{3} + \frac{62\sqrt{3}}{5}$

6760337282. $\frac{43\sqrt{7}}{5} + \frac{32\sqrt{2}}{3}$

6760337283. $\frac{50\sqrt{5}}{3} - \frac{62\sqrt{3}}{5}$

6760337284. $\frac{51\sqrt{6}}{7} - \frac{13\sqrt{7}}{3}$

Question Number : 2 Question Id : 6760332366 Question Type : MCQ Option Shuffling : Yes Is Question Mandatory : No
Correct Marks : 4 Wrong Marks : 1

Given below are two statements :

Statement I :

$$2^{\sin x} + 2^{\cos x} \geq 2^{1-\frac{1}{\sqrt{2}}}, \forall x \in \mathbb{R}.$$

Statement II :

$$4^{\sin x} + 4^{\cos x} \geq 2^{1-\sqrt{2}}, \forall x \in \mathbb{R}.$$

In the light of the above statements, choose the most appropriate answer from the options given below :

Options :

6760337285. Both Statement I and Statement II are correct.

6760337286. Both Statement I and Statement II are incorrect.

6760337287. Statement I is correct but Statement II is incorrect.

6760337288. Statement I is incorrect but Statement II is correct.

Question Number : 3 Question Id : 6760332367 Question Type : MCQ Option Shuffling : Yes Is Question Mandatory : No

Correct Marks : 4 Wrong Marks : 1

Let \vec{a} , \vec{b} and \vec{c} be three non-zero vectors, where $\vec{r} \times \vec{a} = \vec{b} \times \vec{a}$ and

$\vec{r} \cdot \vec{c} = 0$, where $\vec{a} \cdot \vec{b} \neq 0$, $\vec{a} \cdot \vec{c} \neq 0$.

Then, $\left(\frac{\vec{a} \cdot \vec{c}}{a \cdot c}\right) \left(\vec{r} \times \vec{b}\right) + \left(\frac{\vec{b} \cdot \vec{c}}{b \cdot c}\right) \left(\vec{a} \times \vec{b}\right)$ is

Options :

6760337289. $-\left(\begin{matrix} \vec{a} & \vec{b} \end{matrix}\right) \vec{c}$

6760337290. $\vec{0}$

6760337291. \vec{c}

6760337292. $\left(\begin{matrix} \vec{a} & \vec{b} \end{matrix}\right) \vec{c}$

Question Number : 4 Question Id : 6760332368 Question Type : MCQ Option Shuffling : Yes Is Question Mandatory : No Correct Marks : 4 Wrong Marks : 1

Let α and β be two roots of the quadratic equation $ax^2 + bx + c = 0$, where a , b and c are non-zero real numbers. The roots of the equation

$cx^2 + (b + 6c)x + (a + 3b + 9c) = 0$ are

Options :

6760337293. $\frac{\alpha + 3}{\beta}$ and $\frac{\beta - 3}{\alpha}$

6760337294. $\frac{3}{\alpha}$ and $\frac{\beta + 3}{\beta}$

6760337295. $\frac{\alpha - 3}{\alpha}$ and $\frac{3}{\beta}$

6760337296. $\frac{1-3\alpha}{\alpha}$ and $\frac{1-3\beta}{\beta}$

Question Number : 5 Question Id : 6760332369 Question Type : MCQ Option Shuffling : Yes Is Question Mandatory : No Correct Marks : 4 Wrong Marks : 1

Let α be a positive real number such that $x^2 + \alpha x + 6 = 0$ and $\alpha(x^2 + 1) + 12x = 0$ have real roots. Then the maximum possible value of the real root of $\sqrt{3}x^2 - x - 4\sqrt{3}\alpha = 0$ is

Options :

6760337297. $2\sqrt{6}$

6760337298. $\frac{4}{\sqrt{3}}$

6760337299. $3\sqrt{3}$

6760337300. 6

Question Number : 6 Question Id : 6760332370 Question Type : MCQ Option Shuffling : Yes Is Question Mandatory : No Correct Marks : 4 Wrong Marks : 1

Find the equation of a circle which passes through the point $(-1, 0)$ and whose center is the limit of the point of intersection of the lines $x - 3y = 1$, and

$(a - 2)x + 3a^2y = -1$, when a tends to 1.

Options :

6760337301. $81x^2 + 81y^2 - 108x + 18y - 189 = 0$

6760337302. $81x^2 + 81y^2 - 108x + 9y - 189 = 0$

6760337303. $x^2 + y^2 - 54x + 9y - 55 = 0$

6760337304. $9x^2 + 9y^2 + 108x - 18y + 99 = 0$

Question Number : 7 Question Id : 6760332371 Question Type : MCQ Option Shuffling : Yes Is Question Mandatory : No Correct Marks : 4 Wrong Marks : 1

A wire of length 12 meter is shaped into a figure that has a semicircle and a rectangle with one side of rectangle as the diameter of the semicircle. If the area of the figure is maximum, then the circumference of the semicircle is

Options :

6760337305. $\frac{12\pi}{(\pi + 8)}$

6760337306. $\frac{6(\pi + 2)}{(\pi + 8)}$

6760337307. $\frac{\pi + 2}{(\pi + 8)}$

6760337308. $\frac{12}{(\pi + 8)}$

Question Number : 8 Question Id : 6760332372 Question Type : MCQ Option Shuffling : Yes Is Question Mandatory : No Correct Marks : 4 Wrong Marks : 1

If a curve $y = y(x)$ passes through the point $(1, e^2)$ and satisfies the differential

equation $x \frac{dy}{dx} = y (\log_e y - \log_e x + 1)$, $x > 0$, then $y(2)$ is equal to

Options :

6760337309. e^4

6760337310. $2e^4$

6760337311. $\frac{5}{2}e^4$

6760337312. $3e^4$

Question Number : 9 Question Id : 6760332373 Question Type : MCQ Option Shuffling : Yes Is Question Mandatory : No Correct Marks : 4 Wrong Marks : 1

The equation of a plane, which passes through the point $(1, 1, -1)$ and perpendicular to the line of intersection of the planes

$x + y + z = 3$, $x - 2y + z = 3$ is

Options :

6760337313. $x + y + 4z = -2$

6760337314. $x + y + 2z = 0$

6760337315. $x - z = 2$

6760337316. $-x + 2z = -3$

Question Number : 10 Question Id : 6760332374 Question Type : MCQ Option Shuffling : Yes Is Question Mandatory : No Correct Marks : 4 Wrong Marks : 1

The angle of elevation of the top of a tower from a point A due south of the tower is 45° and from a point B due east of the tower is 30° . If $AB = 100$ meters, then the height of the tower is

(Note that tower is perpendicular to the plane which passes through the base of the tower and the points A, B.)

Options :

6760337317. 50 meters

6760337318. $10\sqrt{30}$ meters

6760337319. $\frac{100\sqrt{10}}{\sqrt{3}}$ meters

6760337320. 200 meters

Question Number : 11 Question Id : 6760332375 Question Type : MCQ Option Shuffling : Yes Is Question Mandatory : No Correct Marks : 4 Wrong Marks : 1

If the shortest distance between the plane $2x - 3y + 5z = 4$ and the line

$\frac{x-1}{4} = \frac{y+1}{11} = \frac{z-c}{d}$ is $\frac{7}{\sqrt{152}}$ units, then which of the following is TRUE ?

Options :

6760337321. $0 < c + d \leq 4$

6760337322. $4 < c + d \leq 6$

6760337323. $c + d > 6$

6760337324. $c + d = 0$

Question Number : 12 Question Id : 6760332376 Question Type : MCQ Option Shuffling : Yes Is Question Mandatory : No Correct Marks : 4 Wrong Marks : 1

The area of the region $R = \{(x, y) : |x| \leq 1 - y^2\}$ is

Options :

6760337325. $\frac{2}{3}$

6760337326. $\frac{5}{2}$

6760337327. $\frac{8}{3}$

6760337328. 3

Question Number : 13 Question Id : 6760332377 Question Type : MCQ Option Shuffling : Yes Is Question Mandatory : No Correct Marks : 4 Wrong Marks : 1

The locus of the mirror image of the point $(2, -1)$ through the lines pass through

the point $\left(\frac{5}{2}, 0\right)$ is

Options :

6760337329. $x^2 + y^2 - 5 = 0$

6760337330. $x^2 + y^2 - 5x + 5 = 0$

6760337331. $x^2 + y^2 - 5x - 5 = 0$

6760337332. $x^2 + y^2 + 5y - 5 = 0$

Question Number : 14 Question Id : 6760332378 Question Type : MCQ Option Shuffling : Yes Is Question Mandatory : No Correct Marks : 4 Wrong Marks : 1

Let $y = y(x)$ be the solution of the differential equation

$\cos x \frac{dy}{dx} + y \sin x = x^2 \cos^2 x, x \in \left(-\frac{\pi}{2}, \frac{\pi}{2}\right)$. If $y(0) = 0$, then $y\left(\frac{\pi}{3}\right)$ is equal to

Options :

6760337333. $\frac{\pi^3}{54\sqrt{3}}$

6760337334. $\frac{\pi^3}{162}$

6760337335. $\frac{\pi^3}{81\sqrt{2}}$

$$\frac{\pi^2}{54}$$

6760337336. **Question Number : 15 Question Id : 6760332379 Question Type : MCQ Option Shuffling : Yes Is Question Mandatory : No Correct Marks : 4 Wrong Marks : 1**

Let n be a natural number. Let

$p : n=3k+5$ for some integer k

$q : n^2=3k+1$ for some integer k

$r : n=3k+7$ for some integer k

be logical statements. Then which of the following Boolean expressions is a tautology ?

Options :

6760337337. $q \Rightarrow p$

6760337338. $q \Rightarrow r$

6760337339. $q \Rightarrow p \vee r$

6760337340. $p \wedge q \Rightarrow r$

Question Number : 16 Question Id : 6760332380 Question Type : MCQ Option Shuffling : Yes Is Question Mandatory : No Correct Marks : 4 Wrong Marks : 1

If $\left| \vec{p} + \vec{q} \right| = \lambda$, $\left(\vec{p} + \vec{q} \right) \cdot \left(-7\hat{i} + 2\hat{j} + 3\hat{k} \right) = 4$ and

$\vec{p} \times \left(2\hat{i} + 3\hat{j} + 4\hat{k} \right) = (2i + 3j + 4k) \times \vec{q}$, then λ is equal to

Options :

6760337341. $\frac{\sqrt{29}}{8}$

6760337342. $\sqrt{29}$

6760337343. $\frac{\sqrt{29}}{2}$

6760337344. $2\sqrt{29}$

Question Number : 17 Question Id : 6760332381 Question Type : MCQ Option Shuffling : Yes Is Question Mandatory : No Correct Marks : 4 Wrong Marks : 1

If $Q = \begin{bmatrix} \frac{1}{\sqrt{2}} & \frac{1}{\sqrt{2}} \\ -\frac{1}{\sqrt{2}} & \frac{1}{\sqrt{2}} \end{bmatrix}$ and $A = \begin{bmatrix} x & x \\ 0 & x \end{bmatrix}$, where x is a cube root of unity and

$P = QAQ^T$, then the matrix $Q^T P^{1707} Q$ is

(Where Q^T denote transpose of matrix Q)

Options :

$$6760337345. \begin{bmatrix} 1 & 1 \\ 0 & 1 \end{bmatrix}$$

$$6760337346. \begin{bmatrix} 1 & 569 \\ 0 & 1 \end{bmatrix}$$

$$6760337347. \begin{bmatrix} 1 & 1707 \\ 0 & 1 \end{bmatrix}$$

$$6760337348. \begin{bmatrix} x & 1707x \\ 0 & x \end{bmatrix}$$

Question Number : 18 Question Id : 6760332382 Question Type : MCQ Option Shuffling : Yes Is Question Mandatory : No Correct Marks : 4 Wrong Marks : 1

A plane of an army is flying along the curve $y = x^2 + 2$. A soldier is placed at the point (3, 2). The nearest distance of the soldier from the plane is

Options :

$$6760337349. \sqrt{2}$$

$$6760337350. \sqrt{3}$$

$$6760337351. \sqrt{5}$$

$$6760337352. \sqrt{7}$$

Question Number : 19 Question Id : 6760332383 Question Type : MCQ Option Shuffling : Yes Is Question Mandatory : No Correct Marks : 4 Wrong Marks : 1

The common tangents of two ellipses $\frac{x^2}{a^2} + \frac{y^2}{b^2} = 1$ and $\frac{x^2}{b^2} + \frac{y^2}{a^2} = 1$, $a \neq b$, is also tangent to a circle centered at the origin. Then the equation of the circle is

Options :

6760337353. $x^2 + y^2 = \frac{(a^2 + b^2)}{2}$

6760337354. $x^2 + y^2 = (a^2 + b^2)$

6760337355. $x^2 + y^2 = \sqrt{2}(a^2 + b^2)$

6760337356. $x^2 + y^2 = \frac{(a^2 + b^2)}{\sqrt{2}}$

Question Number : 20 Question Id : 6760332384 Question Type : MCQ Option Shuffling : Yes Is Question Mandatory : No Correct Marks : 4 Wrong Marks : 1

If $0 < \alpha, \beta < \frac{\pi}{2}$ and $\alpha + 2\beta = \pi$, then the minimum value of

$\sin^2(\alpha + \beta) + \sin^2(\alpha - \beta)$ is

Options :

6760337357. $\frac{5}{\sqrt{6}}$

6760337358. $\frac{5}{2\sqrt{6}}$

6760337359. $1 - \frac{3}{2\sqrt{6}}$

6760337360. $1 - \frac{2}{3\sqrt{6}}$

Mathematics Section B

Section Id :	676033153
Section Number :	2
Section type :	Online
Mandatory or Optional :	Mandatory
Number of Questions :	10
Number of Questions to be attempted :	5
Section Marks :	20
Enable Mark as Answered Mark for Review and Clear Response :	Yes
Sub-Section Number :	1
Sub-Section Id :	676033153
Question Shuffling Allowed :	Yes

Question Number : 21 Question Id : 6760332385 Question Type : SA

Correct Marks : 4 Wrong Marks : 0

The base of an equilateral triangle of which one of the vertex is (3, 0), is along the line $x + \sqrt{2}y = 2$. Then the perimeter of the triangle is _____.

Response Type : Numeric

Evaluation Required For SA : Yes

Show Word Count : Yes

Answers Type : Equal

Text Areas : PlainText

Possible Answers :

100

Question Number : 22 Question Id : 6760332386 Question Type : SA

Correct Marks : 4 Wrong Marks : 0

If the variance of $n(>1)$ numbers $a+b, 2a+b, 3a+b, \dots, na+b$ is $3n^2 - 3$,
then the value of $|a|$ is _____.

Response Type : Numeric

Evaluation Required For SA : Yes

Show Word Count : Yes

Answers Type : Equal

Text Areas : PlainText

Possible Answers :

100

Question Number : 23 Question Id : 6760332387 Question Type : SA

Correct Marks : 4 Wrong Marks : 0

The least number of times a man should toss a fair coin, so that the probability of having at least one head is more than 0.9, is _____.

Response Type : Numeric

Evaluation Required For SA : Yes

Show Word Count : Yes

Answers Type : Equal

Text Areas : PlainText

Possible Answers :

100

Question Number : 24 Question Id : 6760332388 Question Type : SA

Correct Marks : 4 Wrong Marks : 0

The number of positive integral solutions of $abc=30$ is _____.

Response Type : Numeric

Evaluation Required For SA : Yes

Show Word Count : Yes

Answers Type : Equal

Text Areas : PlainText

Possible Answers :

100

Question Number : 25 Question Id : 6760332389 Question Type : SA

Correct Marks : 4 Wrong Marks : 0

Let be a function defined as $5f\left(\frac{3}{x+y}\right) = f\left(\frac{3}{x}\right) + f\left(\frac{3}{y}\right)$, for all $x, y > 0$.

If $x+y+z=3$, $x, y, z > 0$, and $f\left(\frac{3}{x}\right) + f\left(\frac{3}{y}\right) + f\left(\frac{3}{z}\right) = cf(1) \neq 0$, then value of

$14c$ is _____.

Response Type : Numeric

Evaluation Required For SA : Yes

Show Word Count : Yes

Answers Type : Equal

Text Areas : PlainText

Possible Answers :

100

Question Number : 26 Question Id : 6760332390 Question Type : SA

Correct Marks : 4 Wrong Marks : 0

If $A = \begin{bmatrix} 1 & 0 & 0 \\ 2 & -1 & 0 \\ 5 & -4 & 2 \end{bmatrix}$ and R, S are two 3×1 column matrices such that $AR = \begin{bmatrix} 2 \\ 1 \\ 3 \end{bmatrix}$

and $AS = \begin{bmatrix} -1 \\ 0 \\ 3 \end{bmatrix}$, then the modulus of $R^T S$ is _____.

Response Type : Numeric

Evaluation Required For SA : Yes

Show Word Count : Yes

Answers Type : Equal

Text Areas : PlainText

Possible Answers :

100

Question Number : 27 **Question Id :** 6760332391 **Question Type :** SA

Correct Marks : 4 **Wrong Marks :** 0

The number of elements a in the open interval $(-2, 2)$ such that the limit

$\lim_{x \rightarrow a} \left([x^2 - 1] - [1 - x] \right)$ does not exist, is _____.

($[x]$ denotes the greatest integer value of x)

Response Type : Numeric

Evaluation Required For SA : Yes

Show Word Count : Yes

Answers Type : Equal

Text Areas : PlainText

Possible Answers :

100

Question Number : 28 Question Id : 6760332392 Question Type : SA

Correct Marks : 4 Wrong Marks : 0

The remainder when $(25)^{98}$ is divided by 11, is _____.

Response Type : Numeric

Evaluation Required For SA : Yes

Show Word Count : Yes

Answers Type : Equal

Text Areas : PlainText

Possible Answers :

100

Question Number : 29 Question Id : 6760332393 Question Type : SA

Correct Marks : 4 Wrong Marks : 0

Let $[x]$ be the greatest integer less than or equal to x . If $\sum_{n=3}^{26} \left[\frac{n^2 + 1}{2} \right] = 13k - 3$,

then k is equal to _____.

Response Type : Numeric

Evaluation Required For SA : Yes

Show Word Count : Yes

Answers Type : Equal

Text Areas : PlainText

Possible Answers :

100

Question Number : 30 Question Id : 6760332394 Question Type : SA

Correct Marks : 4 Wrong Marks : 0

If a_1, a_2, a_3, \dots is an arithmetic progression such that

$a_1 + a_4 + a_8 + a_{13} + a_{17} + a_{20} = 225$, then the sum of its first twenty terms is _____.

Response Type : Numeric

Evaluation Required For SA : Yes

Show Word Count : Yes

Answers Type : Equal

Text Areas : PlainText

Possible Answers :

100

Aptitude Test

Section Id :	676033154
Section Number :	3
Section type :	Online
Mandatory or Optional :	Mandatory
Number of Questions :	50
Number of Questions to be attempted :	50
Section Marks :	200
Enable Mark as Answered Mark for Review and Clear Response :	Yes
Sub-Section Number :	1
Sub-Section Id :	676033154
Question Shuffling Allowed :	Yes

Question Number : 31 Question Id : 6760332395 Question Type : MCQ Option Shuffling : Yes Is Question Mandatory : No Correct Marks : 4 Wrong Marks : 1

Which one of the following is listed as UNESCO world heritage site till December, 2020 ?

Options :

6760337371. Manas National Park

6760337372. Rajaji National Park

6760337373. Jim Corbett National Park

6760337374. Kanha National Park

**Question Number : 32 Question Id : 6760332396 Question Type : MCQ Option Shuffling : Yes Is Question Mandatory : No
Correct Marks : 4 Wrong Marks : 1**

Which type of floor will be helpful for a blind person for walking ?

Options :

6760337375. Rough Tactile Floor

6760337376. Floor with sign language

6760337377. Smooth surface floor

6760337378. Specific tactile pattern floor

**Question Number : 33 Question Id : 6760332397 Question Type : MCQ Option Shuffling : Yes Is Question Mandatory : No
Correct Marks : 4 Wrong Marks : 1**

Sequencing

- (A) Humayun
- (B) Shahjahan
- (C) Aurangzeb
- (D) Akbar
- (E) Jahangir

Choose the correct answer from the options as given below :

Options :

6760337379. A, B, D, E, C

6760337380. A, D, B, E, C

6760337381. A, D, E, B, C

6760337382. A, E, B, D, C

Question Number : 34 Question Id : 6760332398 Question Type : MCQ Option Shuffling : Yes Is Question Mandatory : No

Correct Marks : 4 Wrong Marks : 1

First state of India which has made roof-top rainwater harvesting structures compulsory -

Options :

6760337383. Tamil Nadu

6760337384. Uttarakhand

6760337385. Punjab

6760337386. Odisha

Question Number : 35 Question Id : 6760332399 Question Type : MCQ Option Shuffling : Yes Is Question Mandatory : No Correct Marks : 4 Wrong Marks : 1

Limestone as raw material is used in

Options :

6760337387. Aluminium

6760337388. Cement

6760337389. Plastic

6760337390. Automobile

Question Number : 36 Question Id : 6760332400 Question Type : MCQ Option Shuffling : Yes Is Question Mandatory : No Correct Marks : 4 Wrong Marks : 1

The famous star temple is located in which one of the following states ?

Options :

6760337391. Odisha

6760337392. Madhya Pradesh

6760337393. Uttar Pradesh

6760337394. Haryana

Question Number : 37 Question Id : 6760332401 Question Type : MCQ Option Shuffling : Yes Is Question Mandatory : No

Correct Marks : 4 Wrong Marks : 1

Drawings of the buildings are drawn using –

Options :

6760337395. Reducing scale

6760337396. Actual scale

6760337397. Chord scale

6760337398. Diagonal scale

Question Number : 38 Question Id : 6760332402 Question Type : MCQ Option Shuffling : Yes Is Question Mandatory : No

Correct Marks : 4 Wrong Marks : 1

Which of the following colour shows the ambition ?

Options :

6760337399. Green

6760337400. Black

6760337401. Dark Green

6760337402. Dark Blue

Question Number : 39 Question Id : 6760332403 Question Type : MCQ Option Shuffling : Yes Is Question Mandatory : No Correct Marks : 4 Wrong Marks : 1

‘Mehrangarh Fort’ situated in which city ?

Options :

6760337403. Jodhpur

6760337404. Udaipur

6760337405. Jaipur

6760337406. Jaisalmer

Question Number : 40 Question Id : 6760332404 Question Type : MCQ Option Shuffling : Yes Is Question Mandatory : No Correct Marks : 4 Wrong Marks : 1

‘Frank Lloyd Wright’ the famous architect was born in which country ?

Options :

6760337407. USA (United States of America)

6760337408. Britain

6760337409. Australia

6760337410. Canada

Question Number : 41 Question Id : 6760332405 Question Type : MCQ Option Shuffling : Yes Is Question Mandatory : No Correct Marks : 4 Wrong Marks : 1

Who is the Artist of famous picture ‘The Virgin of the Rocks’ ?

Options :

6760337411. Pablo Picasso

6760337412. Andy Warhole

6760337413. Leonardo da Vinci

6760337414. Uincent Van Gogh

Question Number : 42 Question Id : 6760332406 Question Type : MCQ Option Shuffling : Yes Is Question Mandatory : No

Correct Marks : 4 Wrong Marks : 1

The word 'Torna' is synonymous to which of the following element of the building ?

Options :

6760337415. Arch

6760337416. Pillar

6760337417. Window

6760337418. Gate

Question Number : 43 Question Id : 6760332407 Question Type : MCQ Option Shuffling : Yes Is Question Mandatory : No

Correct Marks : 4 Wrong Marks : 1

Which of the following architects has designed the 'New Central Vista' in New Delhi ?

Options :

6760337419. Charels Correa

6760337420. Christopher Benninger

6760337421. Bimal Patel

6760337422. B. V. Doshi

Question Number : 44 Question Id : 6760332408 Question Type : MCQ Option Shuffling : Yes Is Question Mandatory : No Correct Marks : 4 Wrong Marks : 1

Given below are two statements :

One is labelled as Assertion A and the other is labelled as Reason R.

Assertion A : Traditional buildings all over the world use locally available material for construction.

Reason R : The locally available materials are structurally most stable and hence used in construction of traditional buildings.

In the light of the above statements, choose the correct answer from the options given below.

Options :

6760337423. Both 'A' and 'R' are correct 'R' is the correct explanation of 'A'.

6760337424. Both 'A' and 'R' are correct but 'R' is not the correct explanation of 'A'.

6760337425. 'A' is correct but 'R' is not correct.

6760337426. 'A' is not correct but 'R' is correct.

Question Number : 45 Question Id : 6760332409 Question Type : MCQ Option Shuffling : Yes Is Question Mandatory : No Correct Marks : 4 Wrong Marks : 1

First platinum Rated Green Building in India is located in which city ?

Options :

6760337427. Mumbai

6760337428. New Delhi

6760337429. Hyderabad

6760337430. Bangalore

Question Number : 46 Question Id : 6760332410 Question Type : MCQ Option Shuffling : Yes Is Question Mandatory : No Correct Marks : 4 Wrong Marks : 1

Master Plan of Capital City ‘Amaravati’ was designed in 2014 by which of the following architect ?

Options :

6760337431. Zaha Hadid

6760337432. Bimal Patel

6760337433. Richard Mier

6760337434. Norman Foster

Question Number : 47 Question Id : 6760332411 Question Type : MCQ Option Shuffling : Yes Is Question Mandatory : No Correct Marks : 4 Wrong Marks : 1

9/11 attack was done on which of the following building ?

Options :

6760337435. World Trade Centre

6760337436. Patronus Tower

6760337437. Taj Mahal

6760337438. White House

Question Number : 48 Question Id : 6760332412 Question Type : MCQ Option Shuffling : Yes Is Question Mandatory : No

Correct Marks : 4 Wrong Marks : 1

Which city in India is listed as a UNESCO World Heritage site in 2019 ?

Options :

6760337439. Mysore

6760337440. Jaipur

6760337441. Jaisalmer

6760337442. Banaras

Question Number : 49 Question Id : 6760332413 Question Type : MCQ Option Shuffling : Yes Is Question Mandatory : No

Correct Marks : 4 Wrong Marks : 1

The famous cave 'Elora' is dedicated to which Lord ?

Options :

6760337443. Shiva

6760337444. Vishnu

6760337445. Ganesha

6760337446. Indra

Question Number : 50 Question Id : 6760332414 Question Type : MCQ Option Shuffling : Yes Is Question Mandatory : No Correct Marks : 4 Wrong Marks : 1

The famous theatre 'Rajmandir' is located in which city ?

Options :

6760337447. Gujarat

6760337448. Jaipur

6760337449. Gandhinagar

6760337450. Udaipur

Question Number : 51 Question Id : 6760332415 Question Type : MCQ Option Shuffling : Yes Is Question Mandatory : No Correct Marks : 4 Wrong Marks : 1

Which one of the following answers figure is the correct mirror image of the problem figure with respect to X-X ?

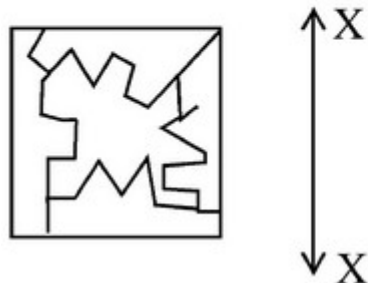

Options :

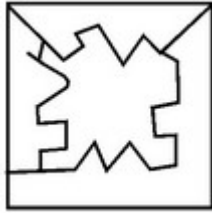

6760337451.

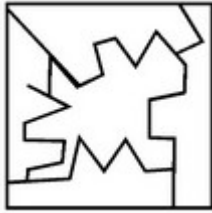

6760337452.

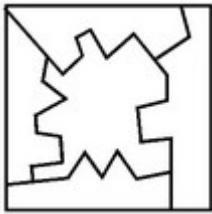

6760337453.

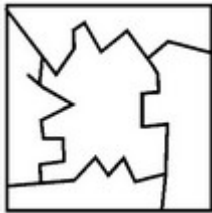

6760337454.

**Question Number : 52 Question Id : 6760332416 Question Type : MCQ Option Shuffling : Yes Is Question Mandatory : No
Correct Marks : 4 Wrong Marks : 1**

Which one of the answers figure is the correct mirror image of problem figure with respect to X-X ?

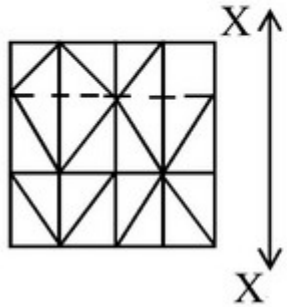

Options :

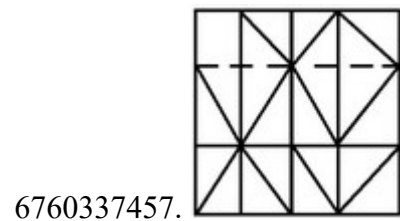
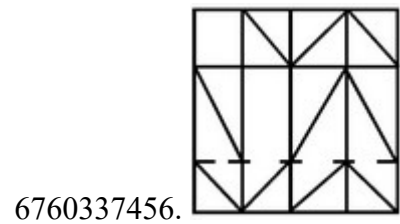
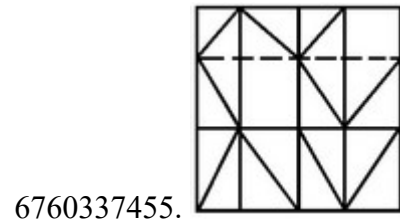

6760337458.

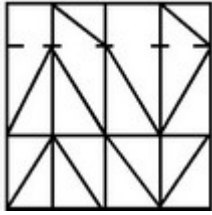

Question Number : 53 Question Id : 6760332417 Question Type : MCQ Option Shuffling : Yes Is Question Mandatory : No Correct Marks : 4 Wrong Marks : 1

Which one of the answer figures is correct mirror image of problem figure with respect to X-X ?

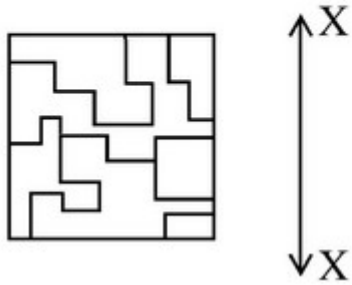

Options :

6760337459.

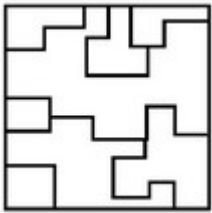

6760337460.

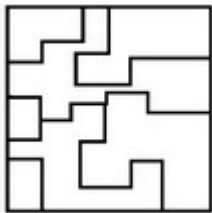

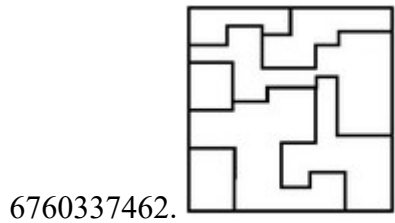
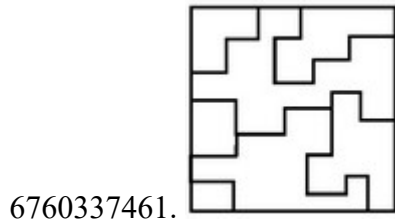

Question Number : 54 Question Id : 6760332418 Question Type : MCQ Option Shuffling : Yes Is Question Mandatory : No Correct Marks : 4 Wrong Marks : 1

Which one of the answer figures is correct mirror image of the problem figure with respect to X-X ?

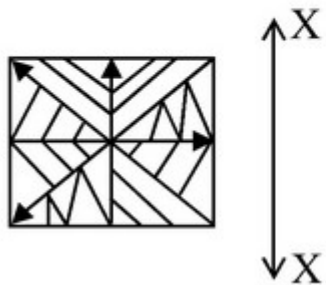

Options :

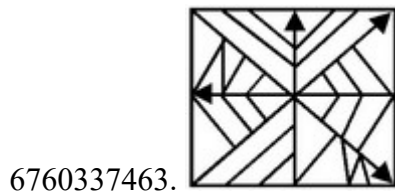

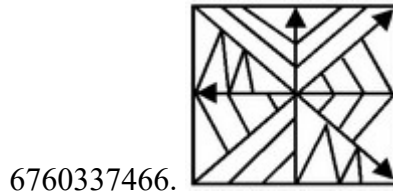
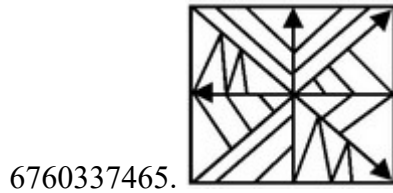
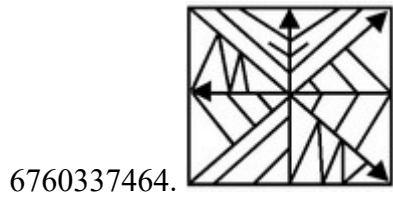

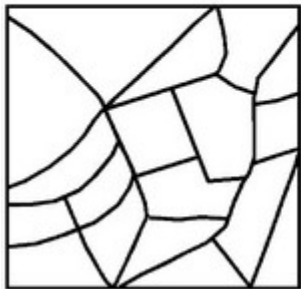

Question Number : 55 Question Id : 6760332419 Question Type : MCQ Option Shuffling : Yes Is Question Mandatory : No Correct Marks : 4 Wrong Marks : 1

One of the following answer figures is hidden in problem figure in same size and direction. Select the correct one.

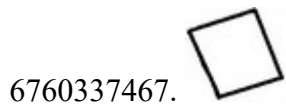

Options :



6760337468. 

6760337469. 

6760337470. 

Question Number : 56 Question Id : 6760332420 Question Type : MCQ Option Shuffling : Yes Is Question Mandatory : No Correct Marks : 4 Wrong Marks : 1

One of the following answer figures is hidden in the problem figure in same size and direction. Select correct one.

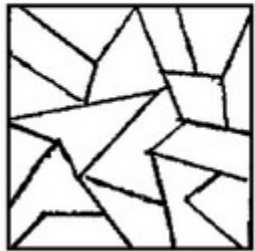

Options :

6760337471. 

6760337472. 

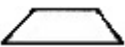
6760337473. 

6760337474.



Question Number : 57 Question Id : 6760332421 Question Type : MCQ Option Shuffling : Yes Is Question Mandatory : No Correct Marks : 4 Wrong Marks : 1

Which one of the answer figures will complete the sequence of the three problem figures ?

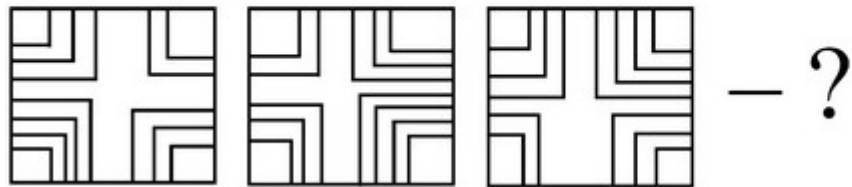

Options :

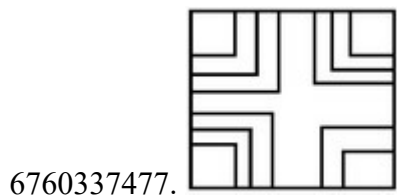
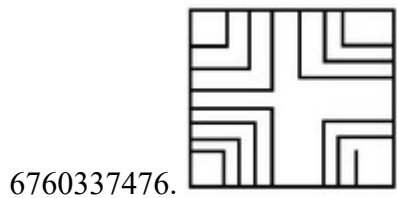
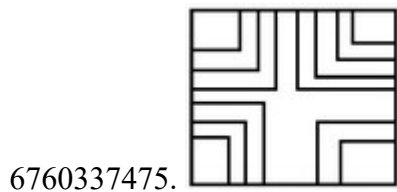

6760337478.

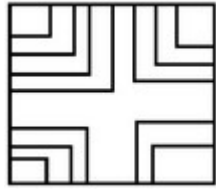

Question Number : 58 Question Id : 6760332422 Question Type : MCQ Option Shuffling : Yes Is Question Mandatory : No
Correct Marks : 4 Wrong Marks : 1

Which one of the answer figures shows the correct view of 3-D image unfold.

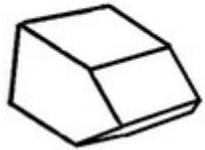

Options :

6760337479.

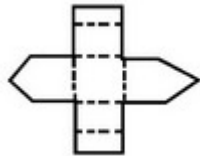

6760337480.

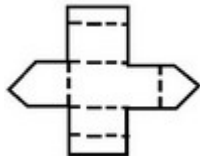

6760337481.

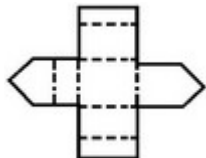

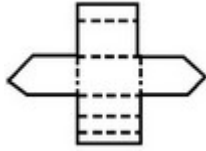

6760337482.

Question Number : 59 Question Id : 6760332423 Question Type : MCQ Option Shuffling : Yes Is Question Mandatory : No Correct Marks : 4 Wrong Marks : 1

The problem figure shows the top view of an object. Identify the correct elevation from the answer figures looking in the direction of arrow.

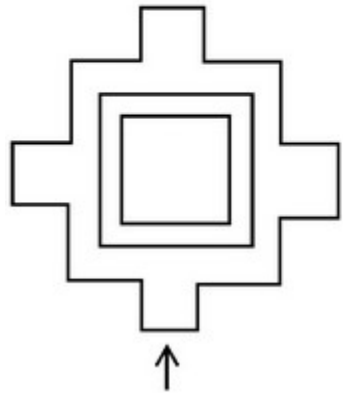

Options :

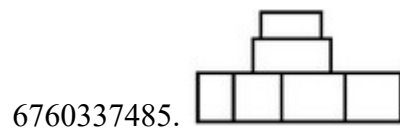
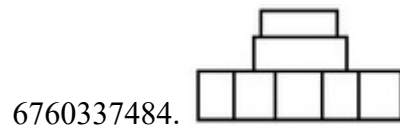
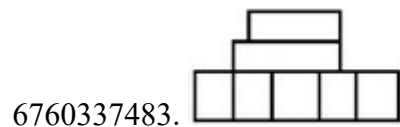

6760337486.

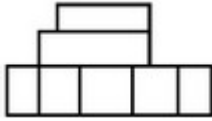

Question Number : 60 Question Id : 6760332424 Question Type : MCQ Option Shuffling : Yes Is Question Mandatory : No Correct Marks : 4 Wrong Marks : 1

The problem figure shows the top view of an object. Identify the correct elevation from the answer figures looking in the direction of arrow.

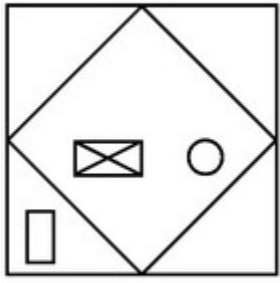

Options :

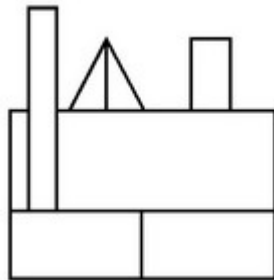

6760337487.

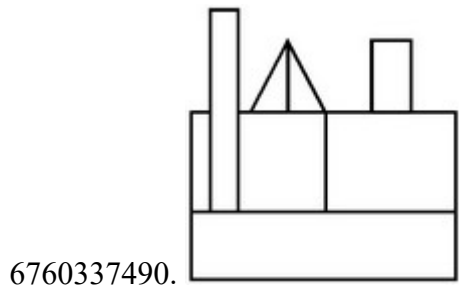
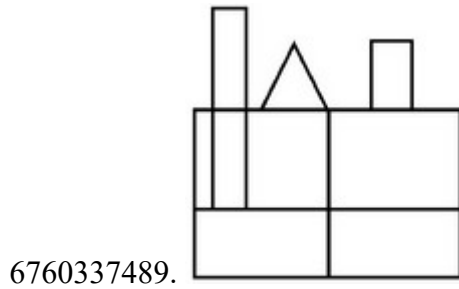
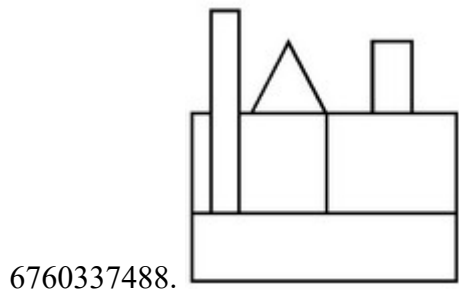

Question Number : 61 Question Id : 6760332425 Question Type : MCQ Option Shuffling : Yes Is Question Mandatory : No Correct Marks : 4 Wrong Marks : 1

The problem figure shows the top view of an object. Which one of the following is not the probable elevation, looking in the direction of arrow ?

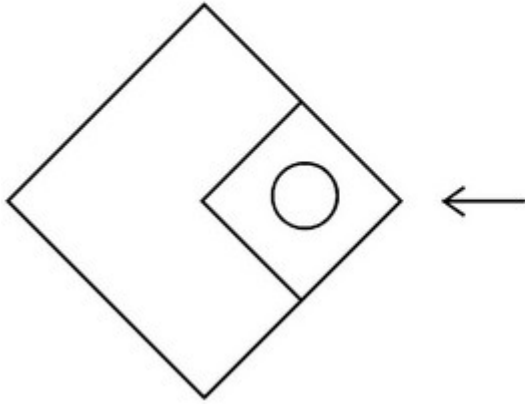

Options :

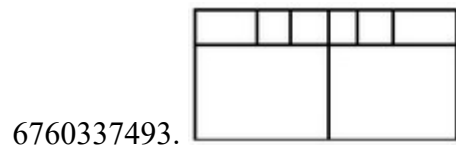
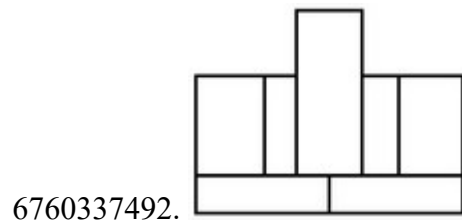
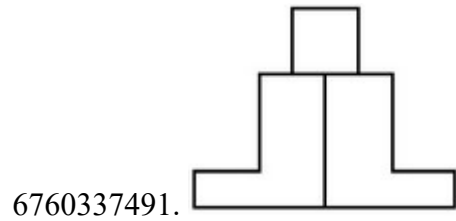

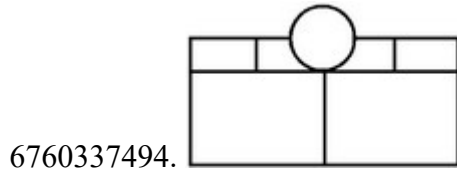

Question Number : 62 Question Id : 6760332426 Question Type : MCQ Option Shuffling : Yes Is Question Mandatory : No Correct Marks : 4 Wrong Marks : 1

The problem figure shows the top view of an object. Identify the correct elevation looking in the direction of arrow, from the answer figures.

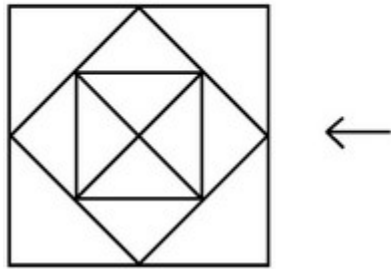

Options :

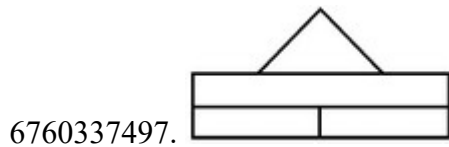
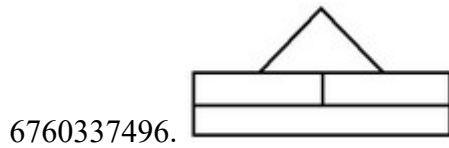
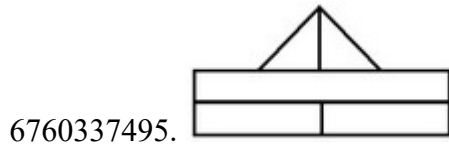

6760337498.

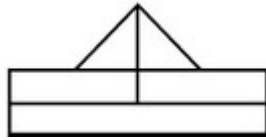

Question Number : 63 Question Id : 6760332427 Question Type : MCQ Option Shuffling : Yes Is Question Mandatory : No Correct Marks : 4 Wrong Marks : 1

The 3D figure shows the view of an object. Identify the correct view looking in the direction of arrow, from the answer figures.

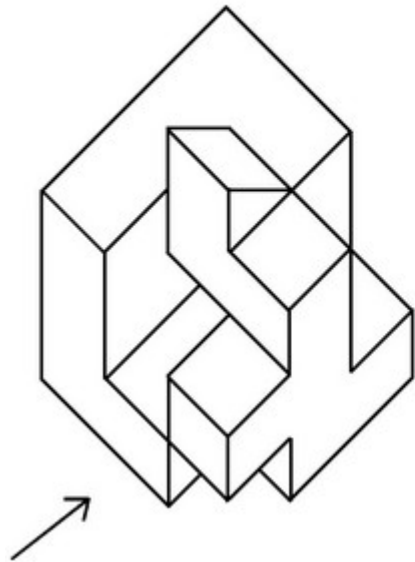

Options :

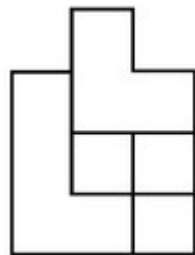

6760337499.

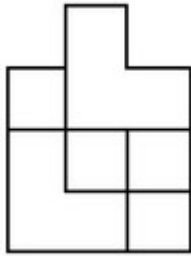

6760337500.

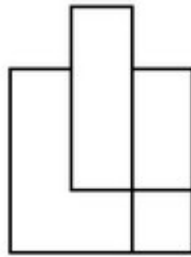

6760337501.

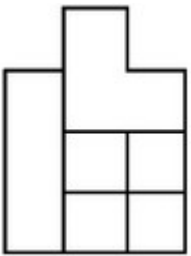

6760337502.

Question Number : 64 Question Id : 6760332428 Question Type : MCQ Option Shuffling : Yes Is Question Mandatory : No Correct Marks : 4 Wrong Marks : 1

The 3D figure shows the view of an object. Identify the correct view looking in the direction of arrow, from the answer figures.

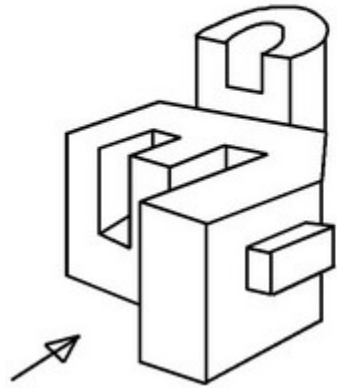

Options :

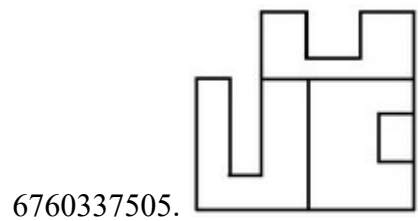
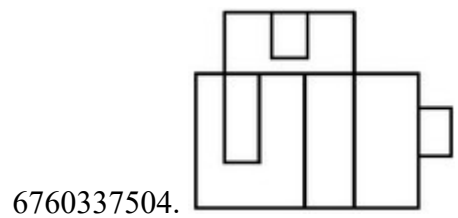
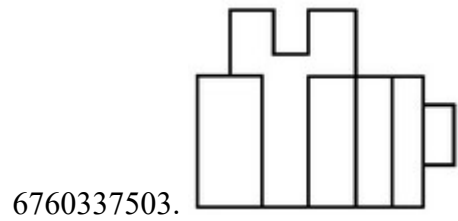

6760337506.

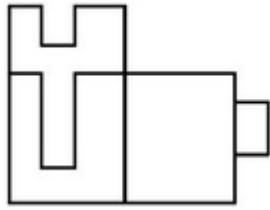

Question Number : 65 Question Id : 6760332429 Question Type : MCQ Option Shuffling : Yes Is Question Mandatory : No

Correct Marks : 4 Wrong Marks : 1

The 3D figure shows the view of an object. Identify the correct view looking in the direction of arrow, from the answer figures.

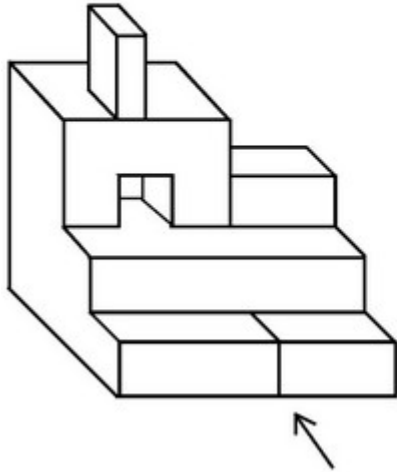

Options :

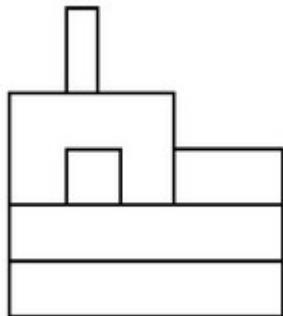

6760337507.

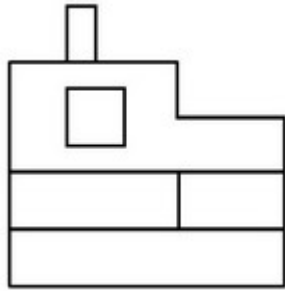

6760337508.

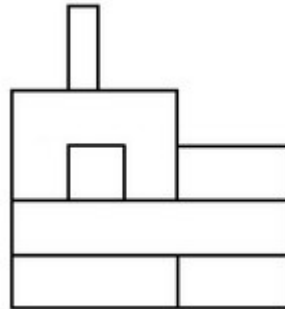

6760337509.

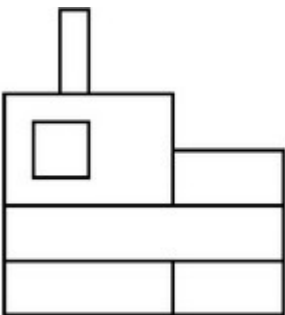

6760337510.

Question Number : 66 Question Id : 6760332430 Question Type : MCQ Option Shuffling : Yes Is Question Mandatory : No Correct Marks : 4 Wrong Marks : 1

The 3D-figure shows view of an object. Identify the correct top view, from the answer figures.

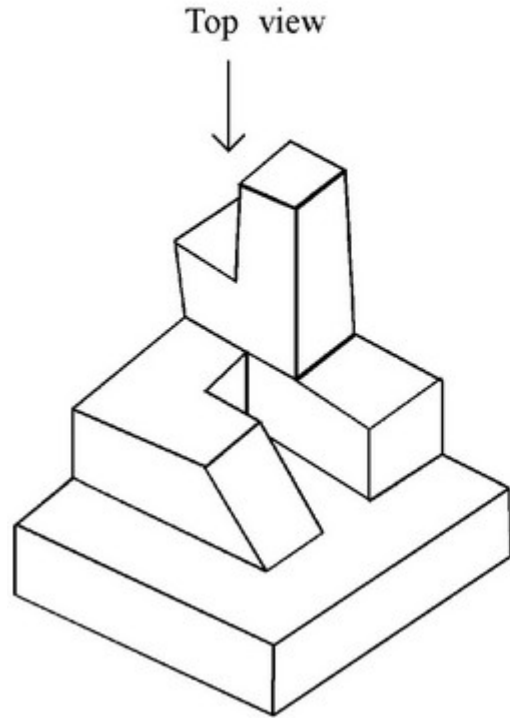

Options :

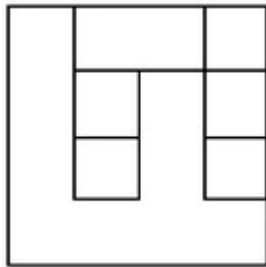

6760337511.

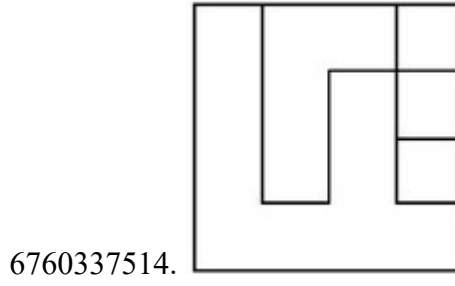
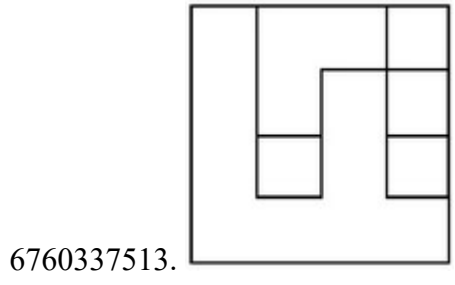
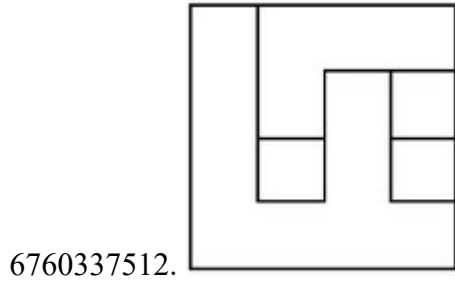

Question Number : 67 Question Id : 6760332431 Question Type : MCQ Option Shuffling : Yes Is Question Mandatory : No Correct Marks : 4 Wrong Marks : 1

The 3D figure shows the view of an object. Identify the correct view looking in the direction of arrow, from the answer figures

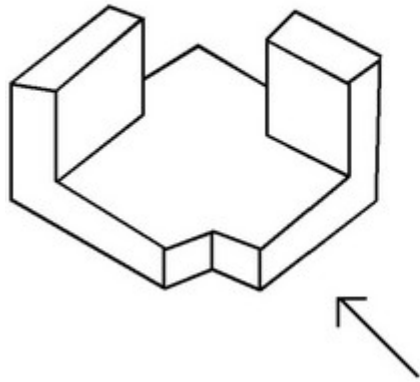

Options :

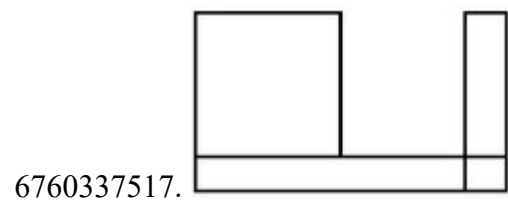
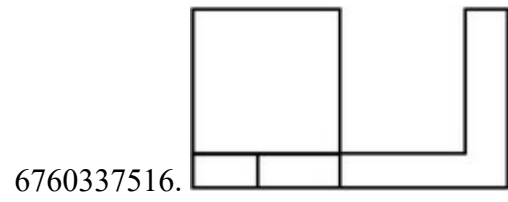
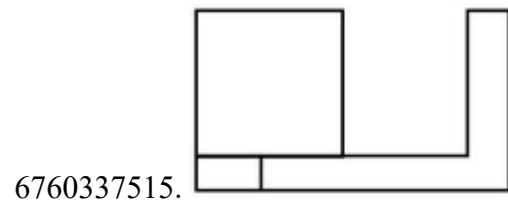

6760337518.

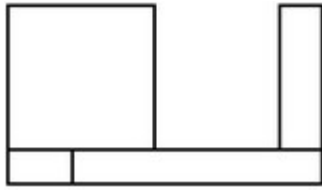

Question Number : 68 Question Id : 6760332432 Question Type : MCQ Option Shuffling : Yes Is Question Mandatory : No Correct Marks : 4 Wrong Marks : 1

The 3D figure shows the view of an object. Identify the correct top view, from the answer figures.

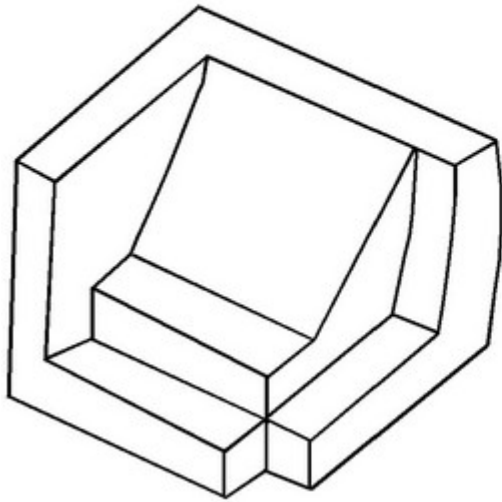

Options :

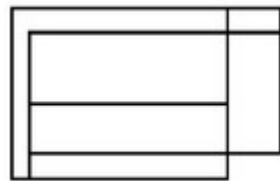

6760337519.

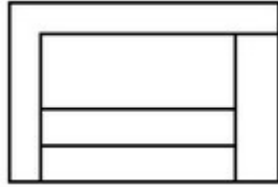

6760337520.

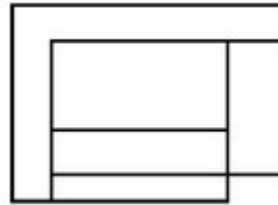

6760337521.

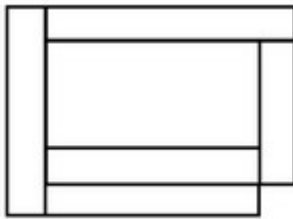

6760337522.

Question Number : 69 Question Id : 6760332433 Question Type : MCQ Option Shuffling : Yes Is Question Mandatory : No Correct Marks : 4 Wrong Marks : 1

The 3D figure shows the view of an object. Identify the correct view looking in the direction of arrow, from the answer figures.

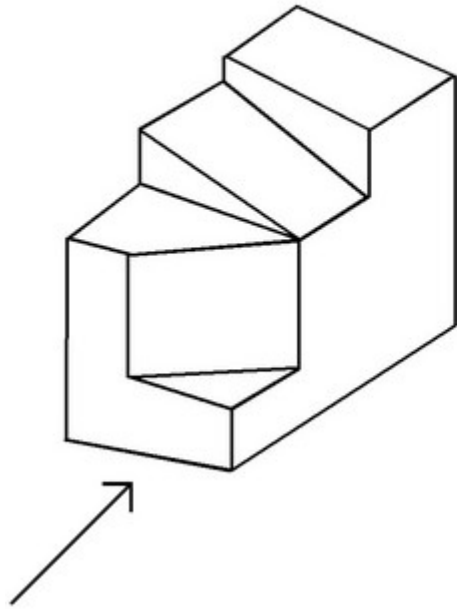

Options :

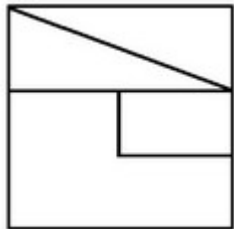

6760337523.

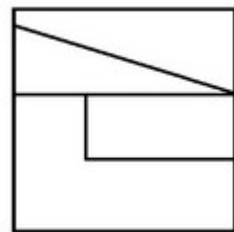

6760337524.

6760337525.

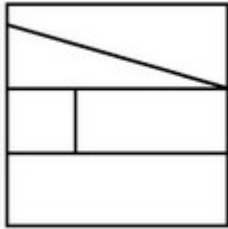

6760337526.

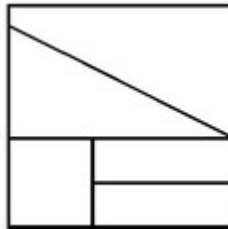

Question Number : 70 Question Id : 6760332434 Question Type : MCQ Option Shuffling : Yes Is Question Mandatory : No Correct Marks : 4 Wrong Marks : 1

The 3D figure shows the view of an object. Identify the correct view looking in the direction of arrow, from the answer figures.

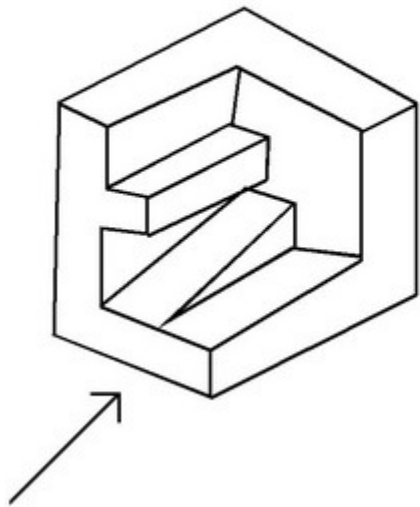

Options :

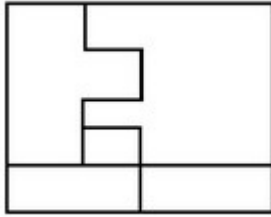

6760337527.

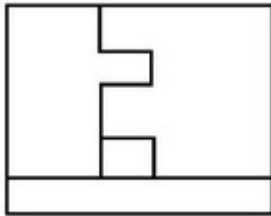

6760337528.

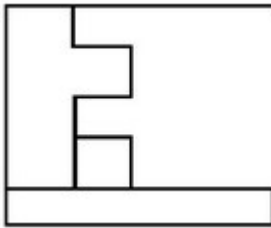

6760337529.

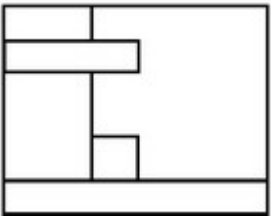

6760337530.

Question Number : 71 Question Id : 6760332435 Question Type : MCQ Option Shuffling : Yes Is Question Mandatory : No Correct Marks : 4 Wrong Marks : 1

The 3D figure shows the view of an object. Identify the correct top view, from the answer figures.

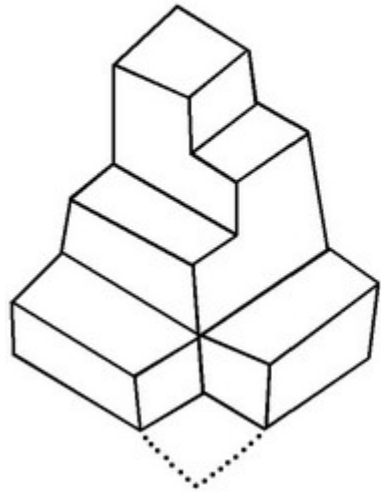

Options :

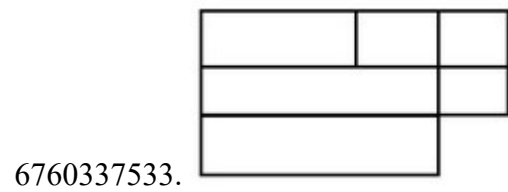
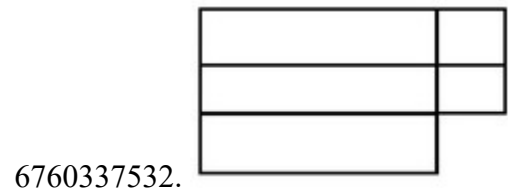
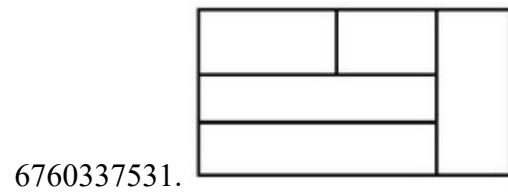

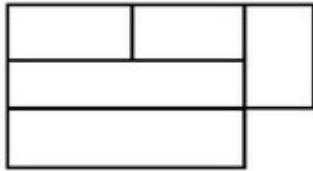

6760337534.

Question Number : 72 Question Id : 6760332436 Question Type : MCQ Option Shuffling : Yes Is Question Mandatory : No

Correct Marks : 4 Wrong Marks : 1

The 3D figure shows the view of an object. Identify the correct view looking in the direction of arrow, from the answer figures.

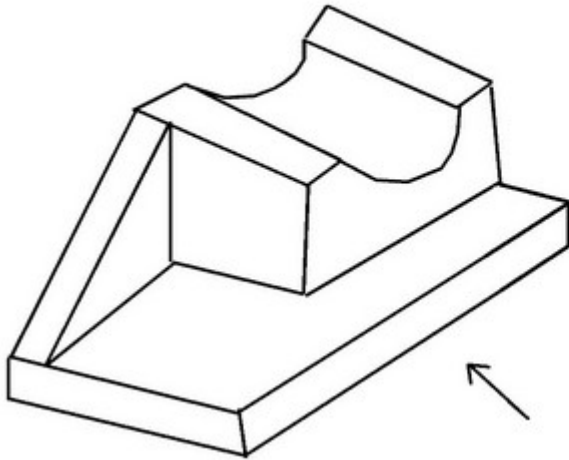

Options :

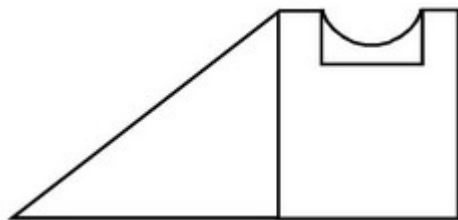

6760337535.

6760337536.

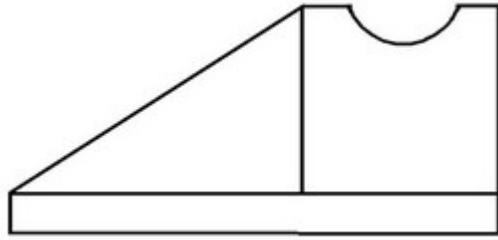

6760337537.

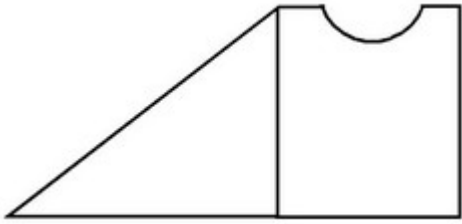

6760337538.

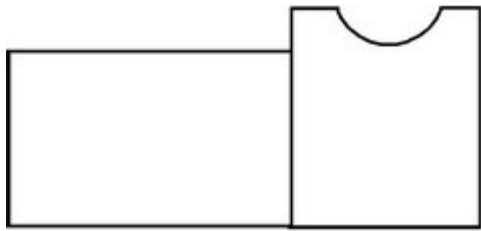

Question Number : 73 Question Id : 6760332437 Question Type : MCQ Option Shuffling : Yes Is Question Mandatory : No Correct Marks : 4 Wrong Marks : 1

The 3D figure shows the view of an object. Identify the correct view looking in the direction of arrow, from the answer figures.

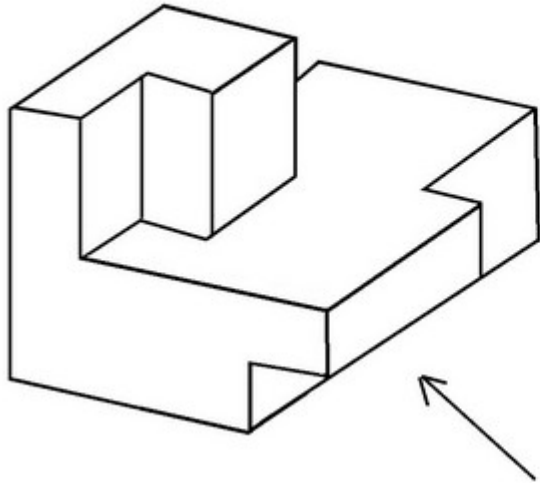

Options :

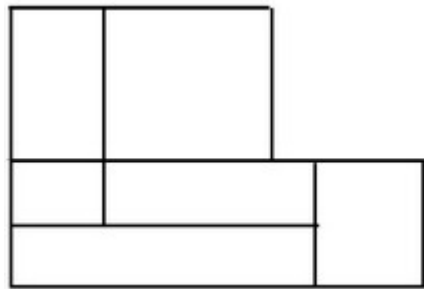

6760337539.

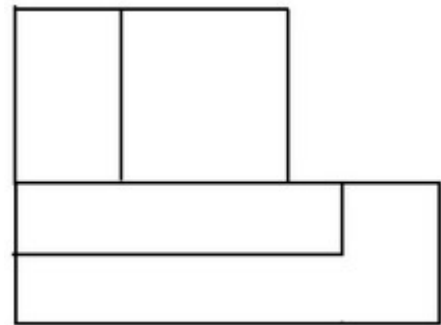

6760337540.

6760337541.

6760337542.

Question Number : 74 Question Id : 6760332438 Question Type : MCQ Option Shuffling : Yes Is Question Mandatory : No Correct Marks : 4 Wrong Marks : 1

The 3D-figure shows the view of an object. Identify the correct view looking in the direction of arrow, from the answer figures.

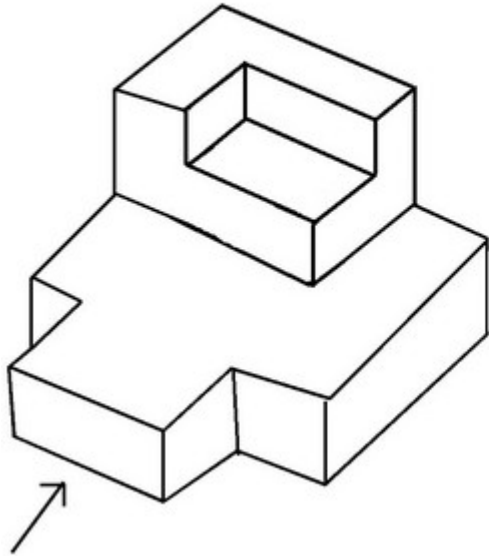

Options :

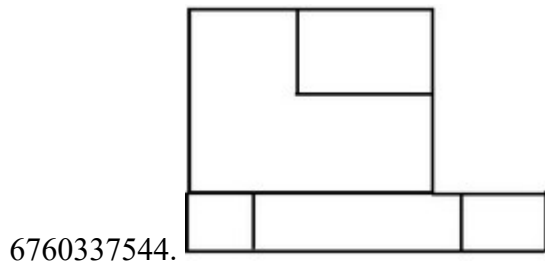
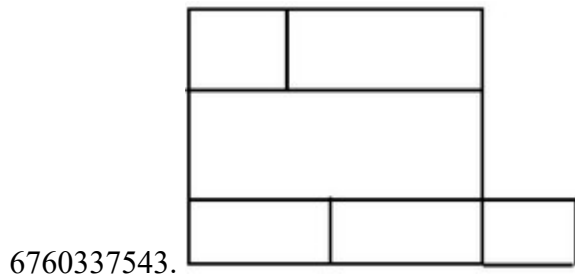

6760337545.

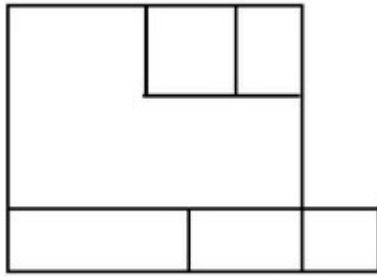

6760337546.

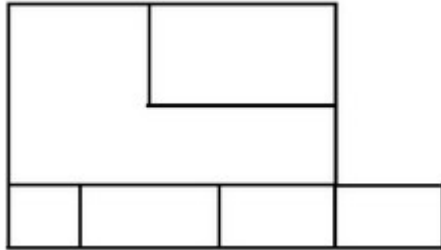

Question Number : 75 Question Id : 6760332439 Question Type : MCQ Option Shuffling : Yes Is Question Mandatory : No Correct Marks : 4 Wrong Marks : 1

The 3D figure shows the view of an object. Identify the correct view looking in the direction of arrow, from the answer figures.

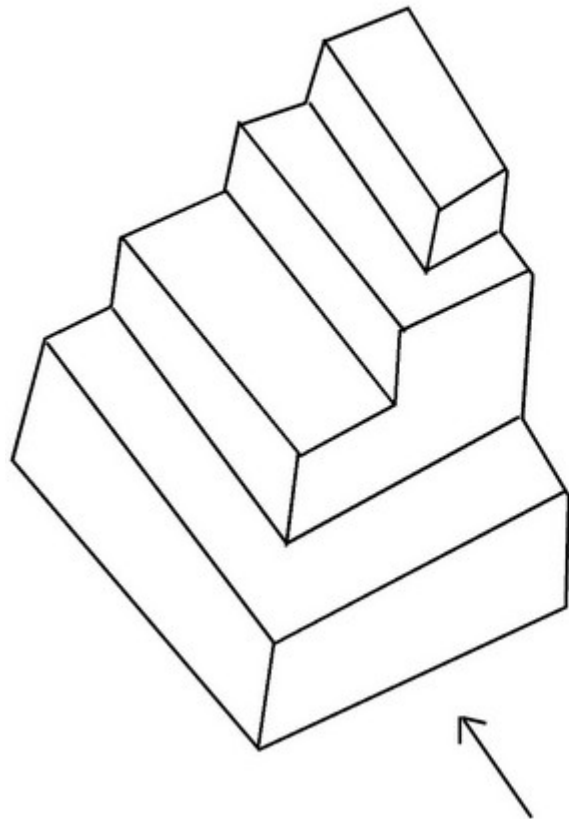

Options :

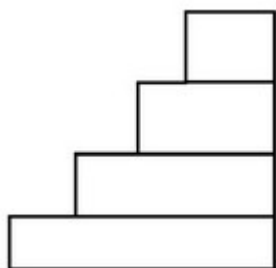

6760337547.

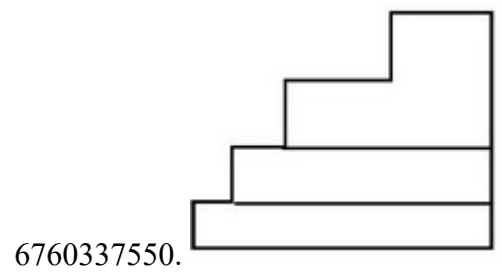
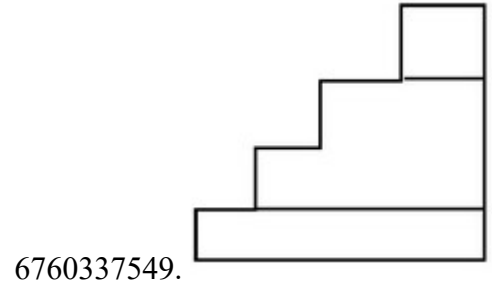
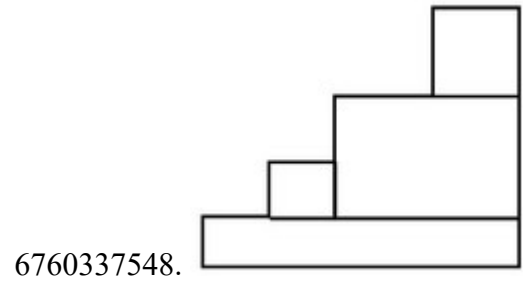

Question Number : 76 Question Id : 6760332440 Question Type : MCQ Option Shuffling : Yes Is Question Mandatory : No Correct Marks : 4 Wrong Marks : 1

Identify the correct shadow from the following answer figures, assuming the position of the sun as shown.

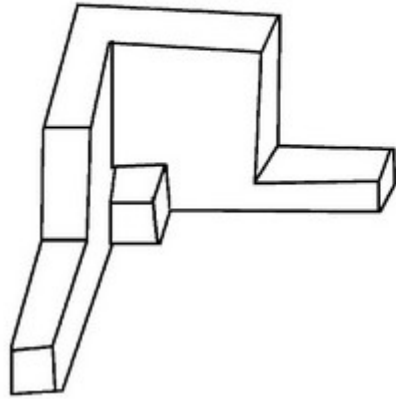

Options :

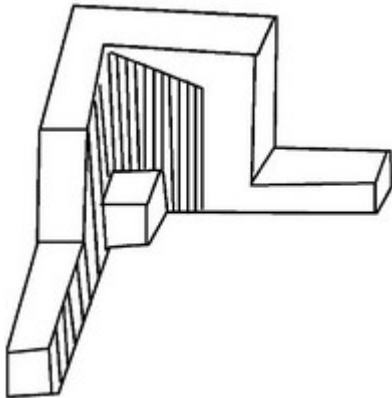

6760337551.

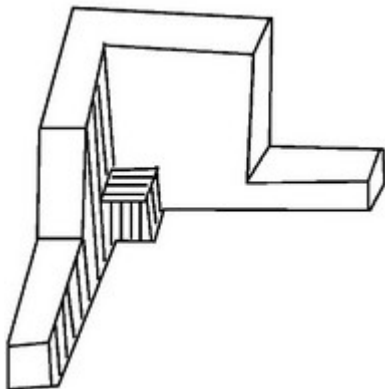

6760337552.

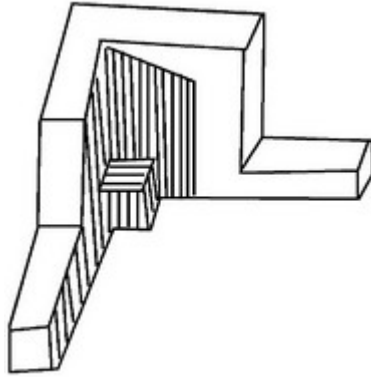

6760337553.

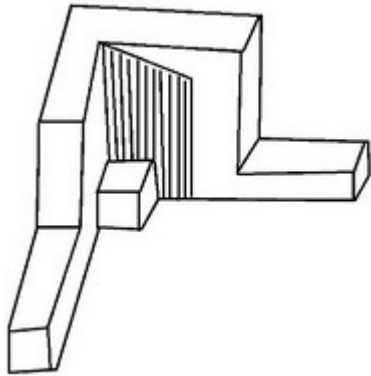

6760337554.

Question Number : 77 Question Id : 6760332441 Question Type : MCQ Option Shuffling : Yes Is Question Mandatory : No Correct Marks : 4 Wrong Marks : 1

In the following figure, the number of triangles are -

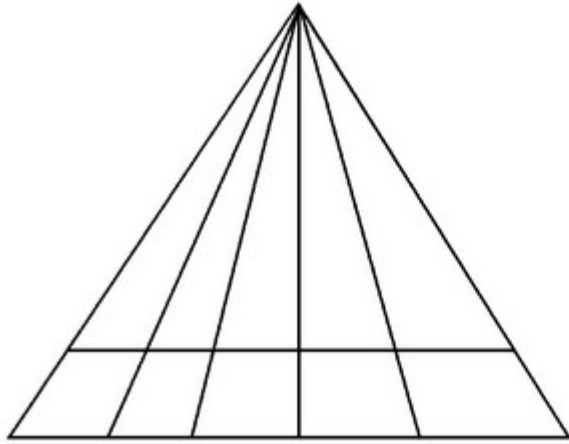

Options :

6760337555. 11

6760337556. 15

6760337557. 30

6760337558. 24

Question Number : 78 Question Id : 6760332442 Question Type : MCQ Option Shuffling : Yes Is Question Mandatory : No Correct Marks : 4 Wrong Marks : 1

One of the following answer figures is hidden in the problem figure in same size and direction. Select correct one.



Options :

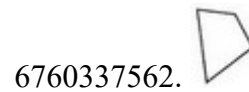
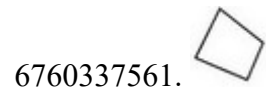
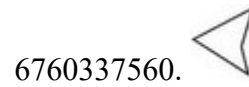
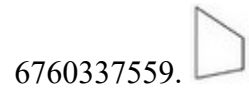

Question Number : 79 Question Id : 6760332443 Question Type : MCQ Option Shuffling : Yes Is Question Mandatory : No Correct Marks : 4 Wrong Marks : 1

One of the following figures is hidden in the problem figure in same size and direction. Select the correct one.



Options :

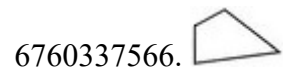
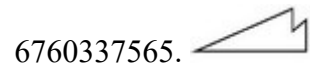
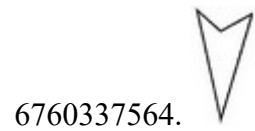
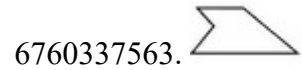

Question Number : 80 Question Id : 6760332444 Question Type : MCQ Option Shuffling : Yes Is Question Mandatory : No
Correct Marks : 4 Wrong Marks : 1

Who designed and planned the modern day city of Bhubaneshwar ?

Options :

6760337567. Alvar Aalto

6760337568. Le-Corbusier

6760337569. Doxiadias

6760337570. Otto Koeings Berger

Drawing

Section Id :	676033155
Section Number :	4
Section type :	Offline
Mandatory or Optional :	Mandatory
Number of Questions :	2
Number of Questions to be attempted :	2
Section Marks :	100
Enable Mark as Answered Mark for Review and Clear Response :	Yes
Sub-Section Number :	1
Sub-Section Id :	676033155
Question Shuffling Allowed :	No

Question Number : 81 Question Id : 6760332445 Question Type : SUBJECTIVE
Correct Marks : 50

Draw proportionate sketch of given reference image in the space provided for the answer of this question. Students can use any black and white rendering techniques of their choice.

OR

Decode the given image and prepare aesthetically balanced composition in frame of your choice. Students can use any black and white rendering techniques of their choice.



Question Number : 82 Question Id : 6760332446 Question Type : SUBJECTIVE

Correct Marks : 50

Use open air theatre, people, musical instruments, river or lake, cafe and create a picture of your choice.

OR

Draw a composition using cool colours. Students can use only triangles and circles to create composition within frame of their own choice.