

Max. Time : $3\frac{1}{2}$ hrs.

Max. Marks : 200

PHYSICS

- For skywave propagation of a 10 MHz signal, what should be the minimum electron density in ionosphere ?
(1) $\approx 10^{22} \text{ m}^{-3}$ (2) $\approx 10^{14} \text{ m}^{-3}$
(3) $\approx 10^6 \text{ m}^{-3}$ (4) $\approx 1.2 \times 10^{12} \text{ m}^{-3}$
- Which of the following logic gates is an universal gate ?
(1) NAND (2) AND
(3) OR (4) NOT
- What should be the maximum acceptance angle at the air core interface of an optical fibre if n_1 and n_2 are the refractive indices of the core and the cladding, respectively ?
(1) $\left[\tan^{-1} \frac{n_1}{n_2} \right]$ (2) $\sin^{-1} (n_2/n_1)$
(3) $\sin^{-1} \sqrt{n_1^2 - n_2^2}$ (4) $\left[\tan^{-1} \frac{n_2}{n_1} \right]$
- A conducting ring of radius 1 metre is placed in an uniform magnetic field B of 0.01 tesla oscillating with frequency 100 Hz with its plane at right angle to B . What will be the induced electric field ?
(1) π volts/m (2) 62 volts/m
(3) 2 volts/m (4) 10 volts/m
- Consider an n-p-n transistor amplifier in common emitter configuration. The current gain of the transistor is 100. If the collector current changes by 1 mA, what will be the change in emitter current ?
(1) 1.1 mA (2) 1.01 mA
(3) 10 mA (4) 0.01 mA
- A telescope has an objective lens of focal length 200 cm and an eye piece with focal length 2 cm. If this telescope is used to see a 50 metre tall building at a distance of 2 km, what is the height of the image of the building formed by the objective lens ?
(1) 2 cm (2) 5 cm (3) 10 cm (4) 1 cm
- The ground state energy of hydrogen atom is -13.6 eV. What is the potential energy of the electron in this state ?
(1) 0 eV (2) -27.2 eV
(3) 2 eV (4) 1 eV
- Solid targets of different elements are bombarded by highly energetic electrons beams. The frequency (f) of the characteristic X-rays emitted from different targets varies with atomic number Z as
(1) $f \propto \sqrt{Z}$ (2) $f \propto Z^{3/2}$
(3) $f \propto Z$ (4) $f \propto Z^2$
- Two infinitely long parallel conducting plates having surface charge densities $+\sigma$ and $-\sigma$ respectively, are separated by a small distance. The medium between the plates is vacuum. If ϵ_0 is the dielectric permittivity of vacuum, then the electric field in the region between the plates is
(1) $\sigma/2\epsilon_0$ volt/metre (2) σ/ϵ_0 volt/metre
(3) $2\sigma/\epsilon_0$ volt/metre (4) 0 volt/metre
- In a semiconducting material the mobilities of electrons and holes are μ_e and μ_h respectively. Which of the following is true
(1) $\mu_e > \mu_h$ (2) $\mu_e < 0$; $\mu_h > 0$
(3) $\mu_e < \mu_h$ (4) $\mu_e = \mu_h$
- The magnetic moment (μ) of a revolving electron around the nucleus varies with principal quantum number n as
(1) $\mu \propto n$ (2) $\mu \propto n^2$
(3) $\mu \propto 1/n$ (4) $\mu \propto 1/n^2$
- A radioactive material has a half-life of 10 days. What fraction of the material would remain after 30 days ?
(1) 0.125 (2) 0.33 (3) 0.25 (4) 0.5
- According to Hubble's law, the red shift (Z) of a receding galaxy and its distance r from earth are related as
(1) $Z \propto r$ (2) $Z \propto r^3$
(3) $Z \propto 1/r^2$ (4) $Z \propto 1/r$
- When exposed to sunlight, thin films of oil on water often exhibit brilliant colours due to the phenomenon of
(1) interference (2) polarization
(3) diffraction (4) dispersion
- "Parsec" is the unit of

- (1) time (2) frequency
 (3) distance (4) angular acceleration

16. The voltage gain of the following amplifier is

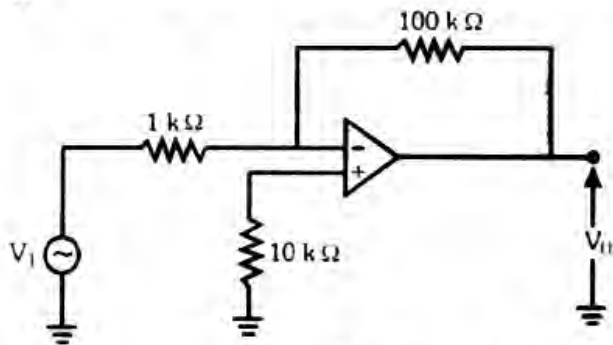

- (1) 10 (2) 9.9 (3) 100 (4) 1000

17. A 50 Hz a.c. source of 20 volts is connected across R and C as shown in figure.

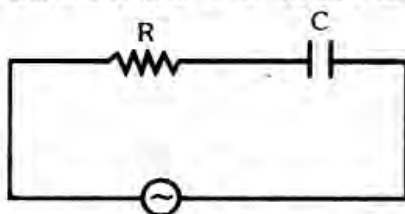

The voltage across R is 12 volt. The voltage across C is

- (1) 10 V (2) 8 V (3) 16 V
 (4) not possible to determine unless values of R and C are given

18. The pressure exerted by an electromagnetic wave of intensity I (watt/m²) on a non reflecting surface is [c is the velocity of light]

- (1) Ic (2) I/c² (3) Ic² (4) I/c

19. In the figure given, the position-time graph of a particle of mass 0.1 kg is shown. The impulse at t = 2 sec is

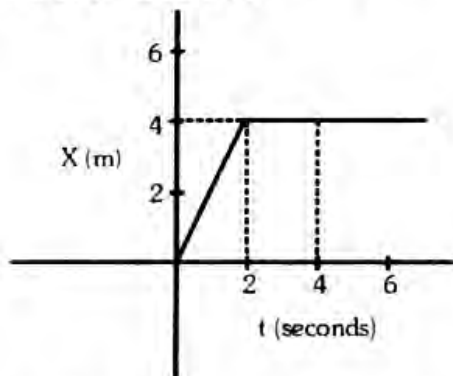

- (1) -0.2 kg m sec⁻¹ (2) -0.4 kg m sec⁻¹
 (3) 0.2 kg m sec⁻¹ (4) 0.1 kg m sec⁻¹

20. A block of mass 10 kg is moving in x-direction with a constant speed of 10 m/sec. It is subjected to a retarding force $F = -0.1 x$.

joule/meter during its travel from x = 20 metre to x = 30 metre. Its kinetic energy will be

- (1) 250 joule (2) 475 joule
 (3) 450 joule (4) 275 joule

21. Energy required to break one bond in DNA is approximately

- (1) ≈ 2.1 eV (2) ≈ 0.01 eV
 (3) ≈ 1 eV (4) ≈ 0.1 eV

22. The condition for a uniform spherical mass m of radius r to be a black hole is [G = gravitational constant and g = acceleration due to gravity]

- (1) $\left(\frac{2 Gm}{r}\right)^{1/2} \leq c$ (2) $\left(\frac{2 gm}{r}\right)^{1/2} = c$
 (3) $\left(\frac{2 Gm}{r}\right)^{1/2} \geq c$ (4) $\left(\frac{gm}{r}\right)^{1/2} \geq c$

23. Which of the following is an amorphous solid?

- (1) sugar (2) salt
 (3) glass (4) diamond

24. For a constant hydraulic stress on an object, the fractional change in the object's volume ($\Delta V/V$) and its bulk modulus (B) are related as

- (1) $\frac{\Delta V}{V} \propto B^2$ (2) $\frac{\Delta V}{V} \propto B^2$
 (3) $\frac{\Delta V}{V} \propto \frac{1}{B}$ (4) $\frac{\Delta V}{V} \propto B$

25. Which of the following functions represents a simple harmonic oscillation?

- (1) $\sin \omega t + \sin 2\omega t$ (2) $\sin^2 \omega t$
 (3) $\sin \omega t - \sin 2\omega t$ (4) $\sin \omega t - \cos \omega t$

26. In case of linearly polarized light, the magnitude of the electric field vector

- (1) increases and decreases linearly with time
 (2) is parallel to the direction of propagation
 (3) does not change with time
 (4) varies periodically with time

27. The circuits shown below acts as

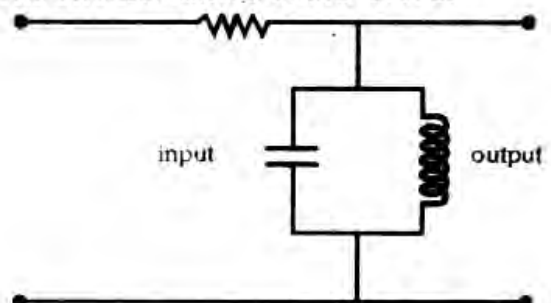

- (1) high pass filter (2) low pass filter
 (3) rectifier (4) tuned filter

28. For ensuring dissipation of same energy in all three resistors (R_1 , R_2 , R_3) connected as shown in figure, their values must be related as

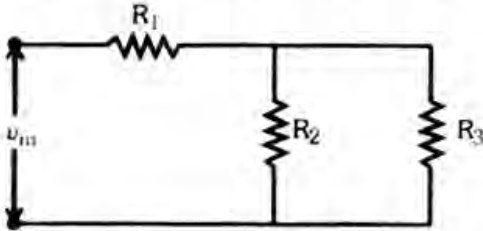

- (1) $R_1 = R_2 + R_3$
 (2) $R_2 = R_3$ and $R_1 = 1/4 R_2$
 (3) $R_1 = R_2 = R_3$
 (4) $R_2 = R_3$ and $R_1 = 4 R_2$

29. The apparent depth of water in cylindrical water tank of diameter $2R$ cm is reducing at the rate of x cm/minute when water is being drained out at a constant rate. The amount of water drained in c.c. per minute is (n_1 = refractive index of air, n_2 = refractive index of water).

- (1) $\pi R^2 x$ (2) $\frac{x \pi R^2 n_2}{n_1}$
 (3) $\frac{x \pi R^2 n_1}{n_2}$ (4) $\frac{2 \pi R n_1}{n_2}$

30. A candle of diameter d is floating on a liquid in a cylindrical container of diameter D ($D \gg d$) as shown in figure. If it is burning at the rate of 2 cm/hour then the top of the candle will

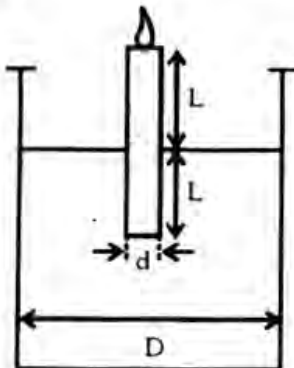

- (1) go up at the rate 1 cm/hour
 (2) fall at the rate of 2 cm/hour
 (3) remain at the same height
 (4) fall at rate of 1 cm/hour
31. A given shaped glass tube having uniform cross section is filled with water and is mounted on a rotatable shaft as shown in figure.

If the tube is rotated with a constant angular velocity ω then

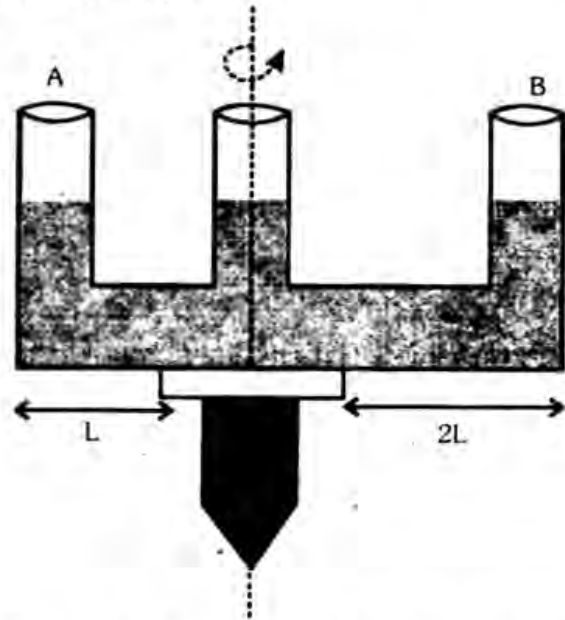

- (1) water level in section A goes up and that in B comes
 (2) water levels remain same in both sections
 (3) water level in both sections A and B go up
 (4) water level in section A comes down and that in B it goes up

32. When a ball is thrown up vertically with velocity v_0 , it reaches a maximum height of h . If one wishes to triple the maximum height then the ball should be thrown with velocity

- (1) $\sqrt{3} v_0$ (2) $3/2 v_0$
 (3) $9 v_0$ (4) $3 v_0$

33. A solid sphere is rolling on a frictionless surface, shown in figure with a translational velocity v m/s. If it is to climb the inclined surface then v should be

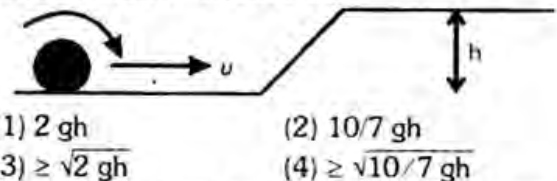

- (1) $2 gh$ (2) $10/7 gh$
 (3) $\geq \sqrt{2} gh$ (4) $\geq \sqrt{10/7} gh$

34. A horizontal platform is rotating with uniform angular velocity around the vertical axis passing through its centre. At some instant of time a viscous fluid of mass m is dropped at the centre and is allowed to spread out and finally fall. The angular velocity during this period

- (1) increases continuously
 (2) remains unaltered
 (3) decreases continuously
 (4) decreases initially and increases again

35. A ladder is leaned against a smooth wall and it is allowed to slip on a frictionless floor. Which figure represents trace of its centre of mass

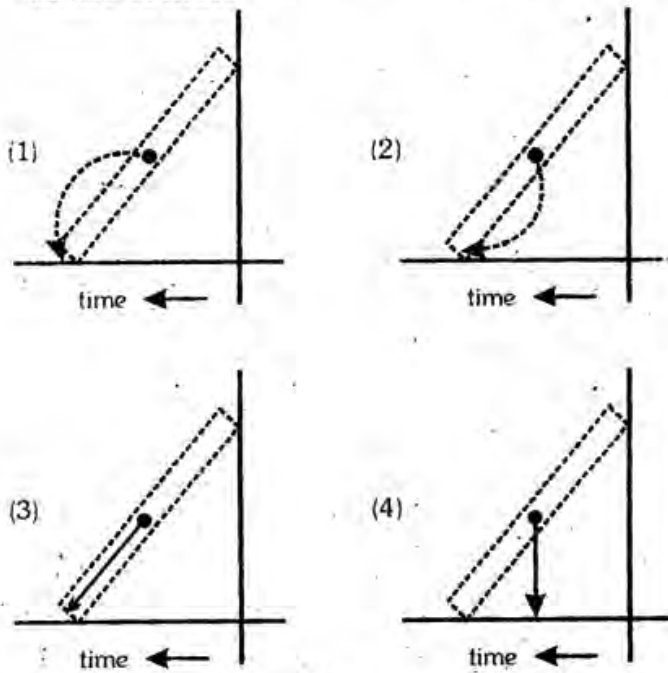

36. A person is standing in an elevator. In which situation he finds his weight less ?

- (1) when the elevator moves upward with uniform velocity
- (2) when the elevator moves downward with uniform velocity
- (3) when the elevator moves upward with constant acceleration
- (4) when the elevator moves downward with constant acceleration

37. Two concentric conducting thin spherical shells A and B having radii r_A and r_B ($r_B > r_A$) are charged to Q_A and $-Q_B$ ($|Q_B| > |Q_A|$). The electrical field along a line, (passing through the centre is)

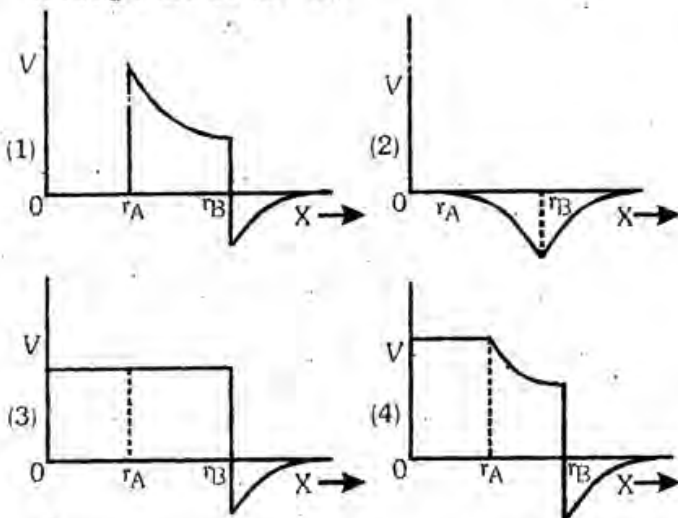

38. A magnet is made to oscillate with a particular frequency, passing through a coil as shown in figure. The time variation of the magnitude of e. m. f. generated across the coil during one cycle is

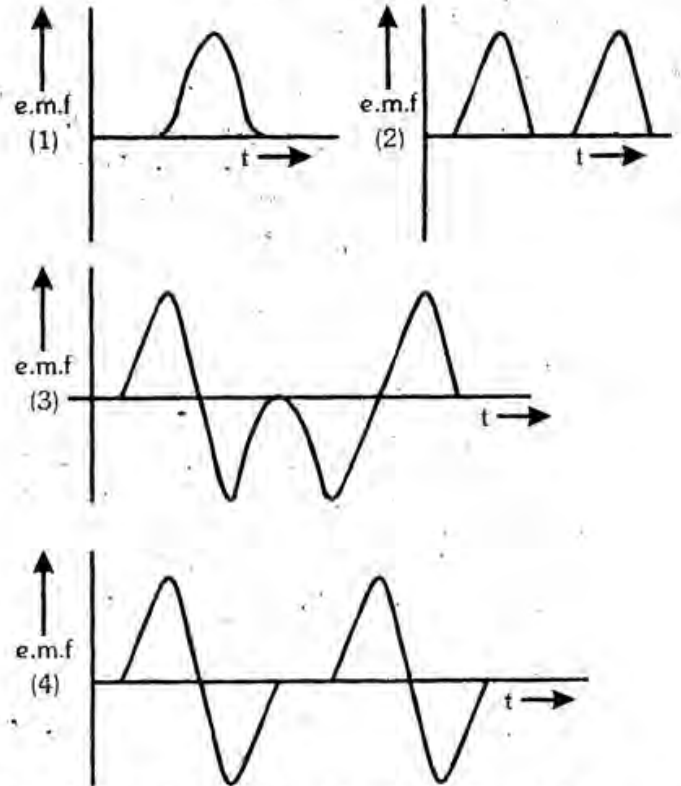
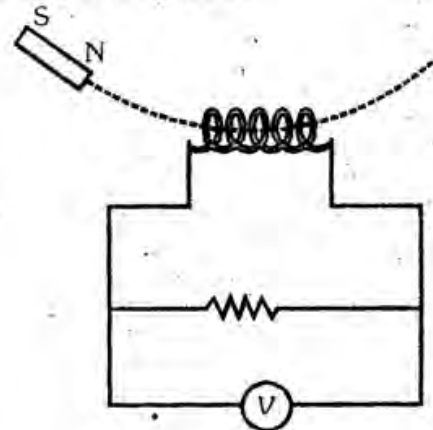

39. Dimension of electrical resistance is

- (1) $ML^{-1}L^3T^3A^2$
- (2) $ML^3T^3A^{-2}$
- (3) $ML^2T^{-3}A^{-1}$
- (4) $ML^2T^{-3}A^{-2}$

40. Four point +ve charges of same magnitude (Q) are placed at four corners of a rigid square frame as shown in figure. The plane of the frame is perpendicular to Z-axis. If a -ve point charge is placed at a distance z away from the above frame ($z \ll L$) then

- (1) it passes through the frame only once
- (2) it moves away from the frame
- (3) -ve charge oscillates along the Z-axis
- (4) it moves slowly towards the frame and stays in the plane of the frame

§ **Directions for questions 41 – 60 :** In each of the following questions, a statement of Assertion (A) is given followed by a corresponding statements of Reason (R) just below it. Of the statements, mark the correct answer as

- (1) If both assertion and reason are true and reason is the correct explanation of assertion
- (2) If both assertion and reason are true but reason is not the correct explanation of assertion
- (3) If assertion is true but reason is false
- (4) If both assertion and reason are false

41. Assertion : Specific gravity of a fluid is a dimensionless quantity.

Reason : It is the ratio of density of fluid to the density of water

42. Assertion : Frictional forces are conservative forces.

Reason : Potential energy can be associated with frictional forces

43. Assertion : By roughening the surface of a glass sheet its transparency can be reduced

Reason : Glass sheet with rough surface absorbs more light.

44. Assertion : A diode lasers are used as optical sources in optical communication

Reason : Diode lasers consume less energy

45. Assertion : Diamond glitters brilliantly

Reason : Diamond does not absorb sunlight

46. Assertion : The energy (E) and momentum (p) of a photon are related by $p = E/c$.

Reason : The photon behaves like a particle

47. Assertion : The clouds in sky generally appear to be whitish

Reason : Diffraction due to clouds is efficient in equal measure at all wavelengths

48. Assertion : Television signals are received through sky-wave propagation

Reason : The ionosphere reflects electromagnetic waves of frequencies greater than a certain critical frequency.

49. Assertion : The logic NOT can be built using diode

Reason : The output voltage and the input voltage of the diode have 180° phase difference

50. Assertion : The resolving power of a telescope is more if the diameter of the objective lens is more

Reason : Objective lens of large diameter collects more light.

51. Assertion : Reversible systems are difficult to find in real world

Reason : Most processes are dissipative in nature

52. Assertion. For a system of particles under central force field, the total angular momentum is conserved.

Reason : The torque acting on such a system is zero.

53. Assertion : Air quickly leaking out of a balloon becomes cooler.

Reason : The leaking air undergoes adiabatic expansion

54. Assertion : It is not possible to use ^{35}Cl as the fuel for fusion energy.

Reason : The binding energy ^{35}Cl is too small

55. Assertion : The number of electrons in a p-type silicon semiconductor is less than the number of electrons in a pure silicon semiconductor at room temperature.

Reason : It is due to law of mass action

56. Assertion : In a common emitter transistor amplifier the input current is much less than the output current.

Reason : The common emitter transistor amplifier has very high input impedance.

57. Assertion : A body that is a good radiator is also a good absorber of radiation at a given wavelength

Reason : According to Kirchoff's law the absorptivity of a body is equal to its emissivity at a given wavelength

58. Assertion : In pressure temperature (P – T) phase diagram of water, the slope of the melting curve is found to be negative

Reason : Ice contracts on melting to water

59. Assertion : For higher temperatures the peak emission wavelength of a black body shifts to lower wavelengths

Reason : Peak emission wavelengths of a blackbody is proportional to the fourth power of temperature

60. Assertion : For Reynold number $R_e > 2000$, the flow of fluid is turbulent

Reason : Inertial forces are dominant compared to the viscous forces at such high Reynold numbers.

CHEMISTRY

61. Among the following molecules

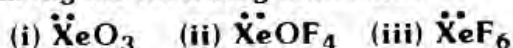

Those having same number of lone pairs on Xe are

- (1) (i) and (ii) only (2) (ii) and (iii)
 (3) (ii) and (iii) only (4) (i), (ii) and (iii) only

62. An aqueous solution of CoCl_2 on addition of excess of concentrated HCl turns blue due to formation of

- (1) $[\text{Co}(\text{H}_2\text{O})_4\text{Cl}_2]$ (2) $[\text{Co}(\text{H}_2\text{O})_6\text{Cl}_4]^{2-}$
 (3) $[\text{CoCl}_4]^{2-}$ (4) $[\text{Co}(\text{H}_2\text{O})_2\text{Cl}_2]$

63. In which of the following pairs both the complexes show optical isomerism?

- (1) $\text{cis-}[\text{Cr}(\text{C}_2\text{O}_4)_2\text{Cl}_2]^-$, $\text{cis-}[\text{Co}(\text{NH}_3)_4\text{Cl}_2]$
 (2) $[\text{Co}(\text{en})_3]\text{Cl}_3$, $\text{cis-}[\text{Co}(\text{en})_2\text{Cl}_2]\text{Cl}$
 (3) $[\text{PtCl}(\text{dien})]\text{Cl}$, $[\text{NiCl}_2\text{Br}_2]^{2-}$
 (4) $[\text{Co}(\text{NO}_3)_3(\text{NH}_3)_3]$, $\text{cis-}[\text{Pt}(\text{en})_2\text{Cl}_2]$

64. The diamagnetic species is

- (1) $[\text{Ni}(\text{CN})_4]^{2-}$ (2) $[\text{NiCl}_4]^{2-}$
 (3) $[\text{CoCl}_4]^{2-}$ (4) $[\text{CoF}_6]^{2-}$

65. In the balanced chemical reaction

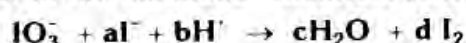

a, b, c and d respectively correspond to

- (1) 5, 6, 3, 3 (2) 5, 3, 6, 3
 (3) 3, 5, 3, 6 (4) 5, 6, 5, 5

66. Among the following pairs of ions, the lower oxidation state in aqueous solution is more stable than the other, in

- (1) Ti^+ , Ti^{3+} (2) Cu^+ , Cu^{2+}
 (3) Cr^{2+} , Cr^{3+} (4) V^{2+} , VO^{2+}

67. The number of P-O-P bridges in the structure of phosphorus pentoxide and phosphorus trioxide are respectively

- (1) 6, 6 (2) 5, 5 (3) 5, 6 (4) 5, 6

68. In diborane, the two H-B-H angles are nearly

- (1) 60° , 120° (2) 95° , 120°
 (3) 95° , 150° (4) 120° , 180°

69. Which of the following gives propyne on hydrolysis

- (1) Al_4C_3 (2) Mg_2C_3
 (3) B_4C (4) La_4C_3

70. The pair of amphoteric hydroxides is

- (1) $\text{Al}(\text{OH})_3$, LiOH
 (2) $\text{Be}(\text{OH})_2$, $\text{Mg}(\text{OH})_2$

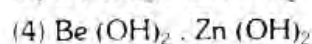
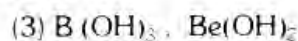

71. Which of the following is a carbonate ore?

- (1) pyrolusite (2) malachite
 (3) diasporite (4) cassiterite

72. ${}_{92}^{238}\text{U}$ emits 8 α -particles and 6 β -particles. The neutron proton ratio in the product nucleus is

- (1) 60/41 (2) 61/40 (3) 62/41 (4) 61/42

73. The correct order for the wavelength of absorption in the visible region is

- (1) $[\text{Ni}(\text{NH}_3)_6]^{2+} < [\text{Ni}(\text{H}_2\text{O})_6]^{2+} < [\text{Ni}(\text{NO}_2)_6]^{4+}$
 (2) $[\text{Ni}(\text{NO}_2)_6]^{4+} < [\text{Ni}(\text{NH}_3)_6]^{2+} < [\text{Ni}(\text{H}_2\text{O})_6]^{2+}$
 (3) $[\text{Ni}(\text{H}_2\text{O})_6]^{2+} < [\text{Ni}(\text{NH}_3)_6]^{2+} < [\text{Ni}(\text{NO}_2)_6]^{4+}$
 (4) $[\text{Ni}(\text{NO}_2)_6]^{4+} < [\text{Ni}(\text{H}_2\text{O})_6]^{2+} < [\text{Ni}(\text{NH}_3)_6]^{2+}$

74. F_2 formed by reacting K_2MnF_6 with

- (1) MnF_4 (2) SbF_5 (3) MnF_3 (4) KSbF_6

75. The isoelectronic pair is

- (1) ClO_2 , ClF_2 (2) IF_2 , I_3
 (3) Cl_2O , ICl_2 (4) ICl_2 , ClO_2

76. Which of the following chemicals are used to manufacture methyl isocyanate that caused "Bhopal Tragedy"

- (i) methylamine (ii) phosgene
 (iii) phosphine (iv) dimethylamine
 (1) (ii) and (iv) (2) (i) and (iii)
 (3) (iii) and (iv) (4) (i) and (ii)

77. α - Particles can be detected using

- (1) gold foil (2) barium sulphate
 (3) thin aluminium sheet
 (4) zinc sulphide screen

78. Which of the following molecules is most suitable to disperse benzene in water?

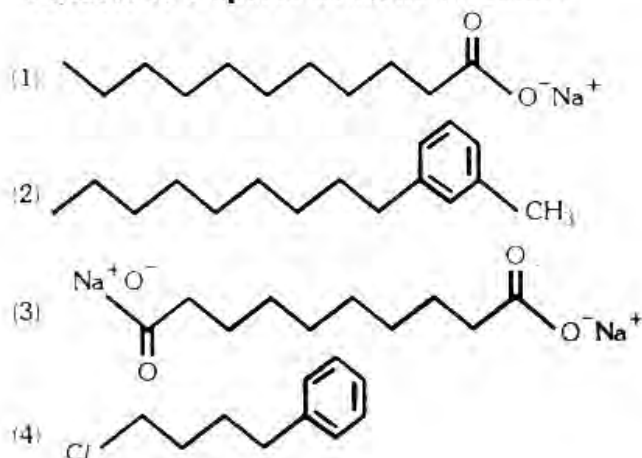

79. The chemical reaction,



taking place in a galvanic cell is represented by the notation

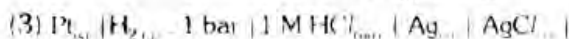
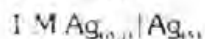
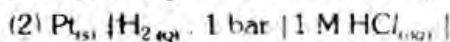
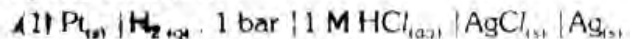

80. If Z is the number of atoms in the unit cell that represents the closest packing sequence . . . A B C A B C . . . , the number of tetrahedral voids in the unit cell is equal to

- (1) Z (2) Z/4 (3) Z/2 (4) 2Z

81. ΔH_f° (298 K) of methanol is given by the chemical equation

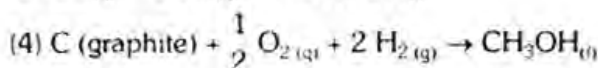
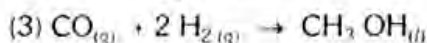
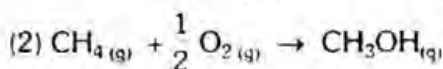
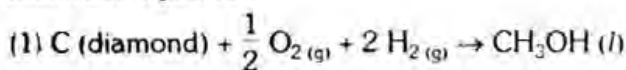

82. An endothermic reaction with high activation energy for the forward reaction is given by the diagram

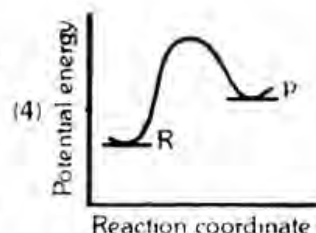
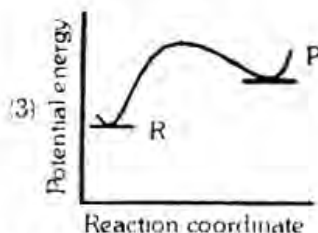
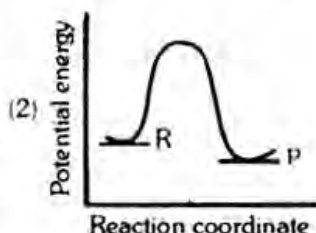
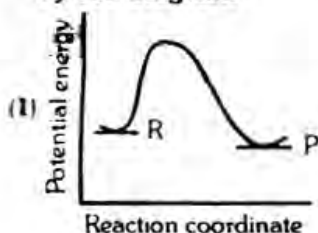

83. When 10 ml of 0.1 M acetic acid ($\text{p}K_a = 5.0$) is titrated against 10 ml of 0.1 M ammonia solution ($\text{p}K_b = 5.0$), the equivalence point occurs at pH

- (1) 9.0 (2) 6.0 (3) 5.0 (4) 7.0

84. The most probable radius (in pm) for finding the electron in He^+ is

- (1) 26.5 (2) 105.8 (3) 0.0 (4) 52.9

85. For the reaction of one mole of zinc dust with one mole of sulphuric acid in a bomb calorimeter, ΔU and w corresponds to

(1) $\Delta U > 0, w > 0$ (2) $\Delta U < 0, w = 0$

(3) $\Delta U < 0, w < 0$ (4) $\Delta U > 0, w = 0$

86. For reaction $a\text{A} \rightarrow x\text{P}$, when $[\text{A}] = 2.2 \text{ mM}$, the rate was found to be 2.4 mM s^{-1} . On reducing concentration of A to half, the rate changes to 0.6 mM s^{-1} . The order of reaction with respect to A is

- (1) 1.5 (2) 2.5 (3) 3.0 (4) 2.0

87. For reaction $2 \text{NOCl}_{(g)} = 2 \text{NO}_{(g)} + \text{Cl}_2_{(g)}$, K_C at 427°C is $3 \times 10^{-6} \text{ L. mol}^{-1}$. The value of K_p is nearly

(1) 1.75×10^{-4} (2) 7.50×10^{-5}

(3) 2.50×10^{-5} (4) 2.50×10^{-4}

88. For the chemical equilibrium,



ΔH_f° can be determined from which one of the following

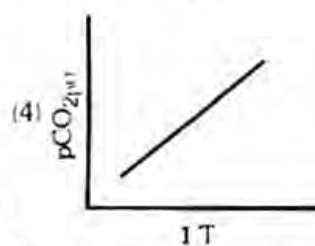
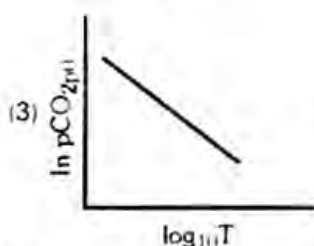
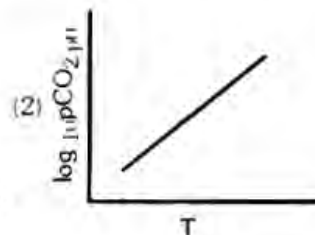
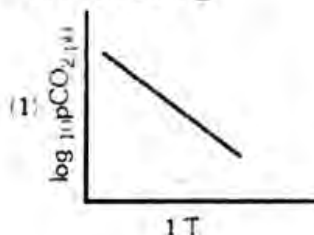

89. Among the following the strongest nucleophile is

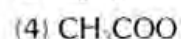
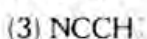
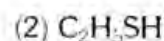
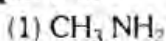

90. The major product formed in the following reaction is

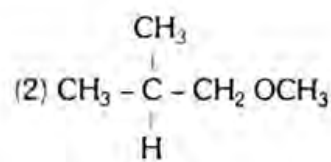
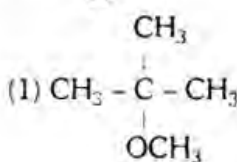
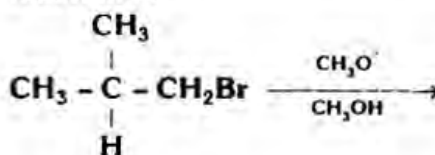

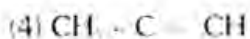
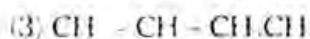

91. The major product obtained on treatment of $\text{CH}_3\text{CH}_2\text{CH}(\text{F})\text{CH}_3$ and $\text{CH}_3\text{O}^- \text{CH}_3\text{OH}$ is

- (1) $\text{CH}_3\text{CH}_2\text{CH}(\text{OCH}_3)\text{CH}_3$
 (2) $\text{CH}_3\text{CH}(\text{OCH}_3)\text{CH}_2\text{CH}_3$
 (3) $\text{CH}_3\text{CH}=\text{CHCH}_3$ (4) $\text{CH}_3\text{CH}_2\text{CH}=\text{CH}_2$

92. Among the following the most stable compound is

- (1) *trans*-1,3-cyclohexanediol
 (2) *cis*-1,2-cyclohexanediol
 (3) *trans*-1,2-cyclohexanediol
 (4) *cis*-1,3-cyclohexanediol

93. 3-Phenylpropene on reaction with HBr gives (as a major product)

- (1) $\text{C}_6\text{H}_5\text{CH}(\text{Br})\text{CH}_2\text{CH}_3$
 (2) $\text{C}_6\text{H}_5\text{CH}_2\text{CH}(\text{Br})\text{CH}_3$
 (3) $\text{C}_6\text{H}_5\text{CH}(\text{Br})\text{CH}=\text{CH}_2$
 (4) $\text{C}_6\text{H}_5\text{CH}_2\text{CH}_2\text{CH}_2\text{Br}$

94. $\text{CH}_3\text{CO}_2\text{C}_2\text{H}_5$ on reaction with sodium ethoxide in ethanol gives A, which on heating in the presence of acid gives B. Compound B is

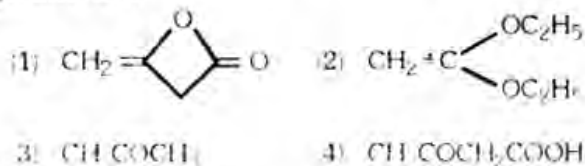

95. Among the following which one does not act as an intermediate in Hofmann rearrangement?

- (1) RNC (2) RNCO
 (3) RCON (4) RCONHBr

96. Pyridine is less basic than triethylamine because

- (1) in pyridine, lone pair of nitrogen is delocalised
 (2) pyridine is a cyclic system
 (3) pyridine has aromatic character
 (4) nitrogen in pyridine is sp^2 hybridised

97. Which one of the following biomolecules is insoluble in water?

- (1) ribonuclease (2) adenine
 (3) haemoglobin (4) α -keratin

98. Correct configuration of the following is

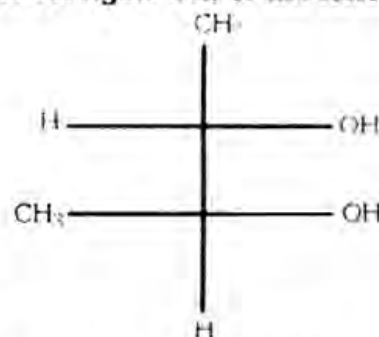

- (1) 1R, 2R (2) 1S, 2R
 (3) 1S, 2S (4) 1R, 2S

99. Which one of the following statements is true for protein synthesis (translation)?

- (1) only one codon codes for an amino acid
 (2) amino acids are directly recognized by m-RNA
 (3) the third base of the codon is less specific
 (4) every t-RNA molecule has more than one amino acid attachment

100. $\text{C}_6\text{H}_5\text{CONHCH}_3$ can be converted into $\text{C}_6\text{H}_5\text{CH}_2\text{NHCH}_3$ by

- (1) Zn-Hg/HCl (2) NaBH_4
 (3) LiAlH_4 (4) $\text{H}_2 - \text{Pd/C}$

§ Directions for questions 101 - 120 : In each of the following questions, a statement of Assertion (A) is given followed by a corresponding statements of Reason (R) just below it. Of the statements, mark the correct answer as

- (1) If both assertion and reason are true and reason is the correct explanation of assertion
 (2) If both assertion and reason are true but reason is not the correct explanation of assertion
 (3) If assertion is true but reason is false
 (4) If both assertion and reason are false

101. Assertion : Reaction of SO_2 and H_2S in the presence of Fe_2O_3 catalyst gives elemental sulphur

Reason : SO_2 is a reducing agent.

102. SiF_6^{2-} is known but SiCl_6^{2-} is not.

Reason : Size of fluorine is small and its lone pair of electrons interacts with d-orbitals of Si strongly.

103. Assertion : Borax bead test is not suitable for Al(III)

Reason : Al_2O_3 is insoluble in water

104. Assertion : Ozone is a powerful oxidising agent in comparison to O_2 .

- Reason : Ozone is diamagnetic but O_2 is paramagnetic.
105. Assertion : Potassium ferrocyanide is diamagnetic whereas potassium ferricyanide is paramagnetic
Reason : Crystal field splitting in ferricyanide ion is greater than that of ferrocyanide ion.
106. Assertion : Addition of NH_4OH to an aqueous solution of $BaCl_2$ in the presence of NH_4Cl (excess) precipitates $Ba(OH)_2$.
Reason : $Ba(OH)_2$ is insoluble in water
107. Assertion : $SeCl_4$ does not have a tetrahedral structure.
Reason : Se in $SeCl_4$ has two lone pairs
108. Assertion : The molecular weight of acetic acid determined by depression in freezing point method in benzene and water was found to be different
Reason : Water is polar and benzene is non polar.
109. Assertion : Compressibility factor for hydrogen varies with pressure with positive slope at all pressures.
Reason : Even at low pressures, repulsive forces dominate hydrogen gas.
110. Assertion : First ionisation energy for nitrogen is lower than oxygen
Reason : Across a period effective nuclear charge decreases.
111. Assertion : B_2 molecule is diamagnetic
Reason : The highest occupied molecular orbitals is of σ type.
112. Assertion : Rate of hydrolysis of methyl chloride to methanol is higher in DMF than in water.
Reason : Hydrolysis of methyl chloride follows second order kinetics
113. Assertion : Galvanized iron does not rust.
Reason : Zinc has a more negative electrode potential than iron.
114. Assertion : Extraction of iron metal from iron oxide ore is carried out by heating with coke.
Reason : The reaction $Fe_2O_3(s) \rightarrow Fe(s) + \frac{3}{2} O_2(g)$ is a spontaneous process.
115. Assertion : Rates of nitration of benzene and hexadeuterobenzene are different
Reason : C - H bond is stronger than C - D bond.
116. Assertion : t-Butyl methyl ether is not prepared by the reaction of t-butyl bromide with sodium methoxide
Reason : Sodium methoxide is a strong nucleophile.
117. Assertion : Maltose is a reducing sugar which gives two moles of D-glucose on hydrolysis
Reason : Maltose has a 1,4- β -glycosidic linkage
118. Assertion : p- $O_2N - C_6H_5COCH_3$ is prepared by Friedel Crafts acylation of nitrobenzene.
Reason : Nitrobenzene easily undergoes electrophilic substitution reaction
119. Assertion : Alkyl isocyanides in acidified water give alkyl formamides
Reason : In isocyanides, carbon first acts as a nucleophile and then as an electrophile
120. Assertion : Cyclopentadienyl anion is much more stable than allyl anion
Reason : Cyclopentadienyl anion is aromatic in character.

BIOLOGY

121. Based on cellular mechanisms there are two major types of regeneration found in the animals. Which one of the following is the correct example of the type mentioned ?
- (1) Epimorphosis - Regeneration of crushed and filtered out pieces of a Planaria into as many new Planarians
 - (2) Morphallaxis - Regeneration of two transversely cut equal pieces of a Hydra into two small Hydras
 - (3) Epimorphosis - Replacement of old and dead erythrocytes by the new ones
 - (4) Morphallaxis - Healing up of a wound in the skin.

122. Which one of the following four secretions is correctly matched with its source, target and nature of action ?

	Secretion	Source	Target	Action
(1)	Gastrin	Stomach lining	Oxyntic cells	Production of HCl
(2)	Inhibin	Sertoli cells	Hypothalamus	Inhibition of secretion of gonadotropin releasing hormone
(3)	Enterokinase	Duodenum	Gall bladder	Release of bile juice
(4)	Atrial Natriuretic Factor (ANF)	Sino atrial node (SAN)	Juxtaglomerular apparatus (JGA)	Inhibition of release of renin

123. Which one of the following four glands is correctly matched with the accompanying description ?

- (1) Pancreas - Delta cells of the Islets of Langerhans secrete a hormone which stimulates glycolysis in liver.
- (2) Parathyroid - Secretes parathormone which promotes movement of calcium ions from blood into bones during calcification
- (3) Thymus - starts undergoing atrophy after puberty
- (4) Thyroid - hyperactivity in young children causes cretinism

124. Given below is a pedigree chart showing the inheritance of a certain sex linked trait in humans.

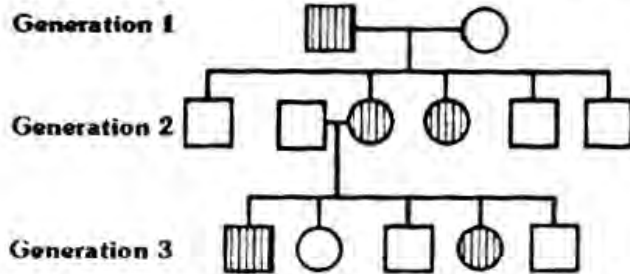

Key :

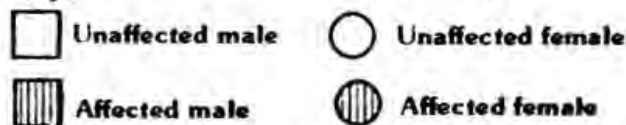

The trait traced in the above pedigree chart is

- (1) recessive Y-linked (2) dominant Y-linked
- (3) dominant X-linked (4) recessive X-linked

125. A cross section at the midpoint of the middle piece of a human sperm will show

- (1) 9 + 2 arrangement of microtubules only
- (2) mitochondria and 9 + 2 arrangement of microtubules
- (3) centriole, mitochondria and 9 + 2 arrangement of microtubules
- (4) centriole and mitochondria

126. Which one of the following is a correct statement ?

- (1) The anticoagulant hirudin is being produced from transgenic *Brassica napus* seeds
- (2) "Flavr Savr" variety of tomato has enhanced the production of ethylene which improves its taste
- (3) "Bt" in "Bt-cotton" indicates that it is a genetically modified organism produced through biotechnology
- (4) Somatic hybridisation involves fusion of two complete plant cells carrying desired genes

127. An insect bite may result in inflammation of that spot. This is triggered by the alarm chemicals such as :

- (1) interferons and histones
- (2) histamine and kinins
- (3) histamine and dopamine
- (4) interferons and opsonin

128. Which one of the following pairs of geographical areas show maximum biodiversity in our country ?

- (1) Kerala and Punjab
- (2) Sunderbans and Rann of Kutch
- (3) Eastern Ghats and West Bengal
- (4) Eastern Himalaya and Western Ghats

129. Genetic diversity in agricultural crops is threatened by :

- (1) intensive use of biopesticides
- (2) extensive intercropping
- (3) intensive use of fertilizers
- (4) introduction of high yielding varieties

130. One of the ex situ conservation methods for endangered species is

- (1) national parks (2) cryopreservation
- (3) wildlife sanctuaries (4) biosphere reserves

131. Formation of non-functional methaemoglobin causes blue-baby syndrome. This is due to

- (1) deficiency of iron in food
- (2) excess of arsenic concentration in drinking water
- (3) increased methane content in the atmosphere
- (4) excess of nitrates in drinking water

132. Two of the body parts which do not appear in MRI may be :

- (1) scapula and canines
- (2) molar teeth and eye lens
- (3) tendons and premolars
- (4) ligaments and ribs

133. A young drug addict used to show symptoms of depressed brain activity, feeling of calmness, relaxation and drowsiness. Possibly he was taking

- (1) marijuana
- (2) amphetamine
- (3) valium
- (4) pethidine

134. Antigen binding site in an antibody is found between

- (1) two heavy chains
- (2) one heavy and one light chain
- (3) two light chains
- (4) either between two light chains or between one heavy and one light chain depending upon the nature of antigen

135. Which one of the following events is correctly matched with the time period in a normal menstrual cycle ?

- (1) endometrium secretes nutrients for implantation : 11-18 days
- (2) endometrium regenerates : 5-10 days
- (3) release of egg : 5th day
- (4) rise in progesterone level : 1-15 days

136. A tumor inducing plasmid widely used in the production of transgenic plants is that of

- (1) *Agrobacterium tumefaciens*
- (2) *Escherichia coli*
- (3) *Bacillus thuringiensis*
- (4) *Staphylococcus aureus*

137. Which one of the following statement pertaining to pollutants is correct ?

- (1) methylmercury in water may cause "Itai itai" disease.
- (2) excess fluoride in drinking water causes osteoporosis
- (3) excess cadmium in drinking water causes black foot disease
- (4) DDT is a non-biodegradable pollutant

138. Which one of the following statements is correct with respect to salt water balance inside the body of living organisms ?

- (1) The body fluids of fresh water animals are generally hypotonic to surrounding water.
- (2) Salmon fish excretes lot of stored salt through gill membrane when in fresh water
- (3) *Paramecium* discharge concentrated salt solution by contractile vacuoles

(4) when water is not available camels do not produce urine but store urea in tissues.

139. The "cri-du-chat" syndrome is caused by change in chromosome structure involving

- (1) translocation
- (2) deletion
- (3) duplication
- (4) inversion

140. The family containing mustard and its main characters are

- (1) Solanaceae - Pentamerous flowers, five stamens, bicarpellary gynoecium, berry type fruit
- (2) Brassicaceae - Tetramerous flowers, six stamens, bicarpellary gynoecium, siliqua type fruit
- (3) Poaceae - Trimerous flowers, three stamens, monocarpellary gynoecium, caryopsis type of fruit.
- (4) Brassicaceae - pentamerous flowers, many stamens, pentacarpellary gynoecium, capsule type fruit

141. Grain colour in wheat is determined by three pairs of polygenes. Following the cross AABBCc (dark colour) x aabbcc (light colour), in F₂ generation what proportion of the progeny is likely to resemble either parent ?

- (1) half
- (2) none
- (3) less than 5 percent
- (4) one third

142. Which one of the following statements pertaining to plant structure is correct ?

- (1) sieve tube elements possess cytoplasm but no nuclei
- (2) cork lacks stomata, but lenticels carry out transpiration
- (3) the shoot apical meristem has a quiescent centre.
- (4) passage cells help in transfer of food from cortex to phloem

143. When synapsis is complete all along the chromosome, the cell is said to have entered a stage called

- (1) diakinesis
- (2) diplotene
- (3) zygotene
- (4) pachytene

144. Primary source of allelic variation is

- (1) mutation
- (2) recombination
- (3) polyploidy
- (4) independent assortment

145. Many cells function properly and divide mitotically even though they do not have

- (1) plasma membrane
- (2) plastids
- (3) mitochondria
- (4) cytoskeleton

146. Three of the following statements regarding cell organelles are correct while one is wrong. Which one is wrong ?

- (1) Sphaerosomes are single membrane bound and are associated with synthesis and storage of lipids
- (2) Lysosomes are double membraned vesicles budded off from Golgi apparatus and contain digestive enzymes
- (3) Endoplasmic reticulum consists of a network of membranous tubules and helps in transport, synthesis and secretion
- (4) Leucoplasts are bound by two membranes, lack pigment but contain their own DNA and protein synthesizing machinery.

147. In which one of the following would you expect to find glyoxysomes ?

- (1) root hairs
- (2) endosperm of wheat
- (3) palisade cells in leaf
- (4) endosperm castor

148. Which one of the following correctly represents an organism and its ecological niche?

- (1) vultures and dense forest
- (2) vallisneria and pond
- (3) plant lice (aphids) and leaf
- (4) desert locust (schistocerca) and desert

149. Given below is one of the types of ecological pyramids. This type represents

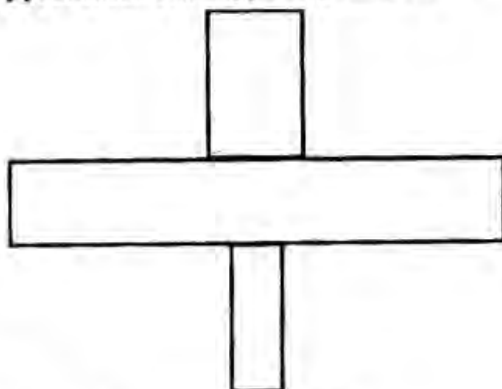

- (1) pyramid of biomass in a lake
- (2) pyramid of biomass in a fallow land
- (3) pyramid of numbers in a grassland
- (4) energy pyramid in a spring.

150.

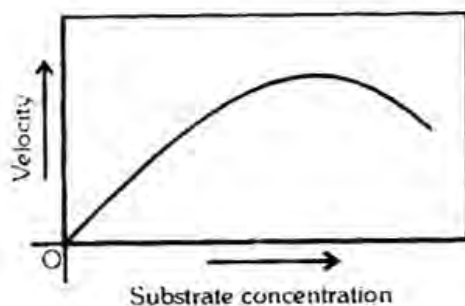

The given graph shows the effect of substrate concentration on the rate of reaction of the enzyme green gram-phosphatase. What does the graph indicate?

- (1) at higher substrate concentration the pH increases
- (2) Formation of an enzyme-substrate complex
- (3) The rate of enzyme reaction is directly proportional to the substrate concentration
- (4) Presence of an enzyme inhibitor in the reaction mixture

151. Which one of the following groups of structures/organs have similar function ?

- (1) Incisors of rat, gizzard (proventriculus) of cockroach and tube feet of starfish
- (2) Nephridia in earthworm, Malpighian tubules in cockroach and urinary tubules in rat
- (3) Antennae of cockroach, tympanum of frog and clitellum of earthworm
- (4) Typhlosole in earthworm, intestinal villi in rat and contractile vacuole in *Amoeba*

152. Given below is a diagram of the bones of the left human hindlimb as seen from front. It has certain mistakes in labeling. Two of the wrongly labelled bones are :

- (1) fibula and phalanges
- (2) femur and fibula
- (3) tibia and tarsals
- (4) tarsals and femur

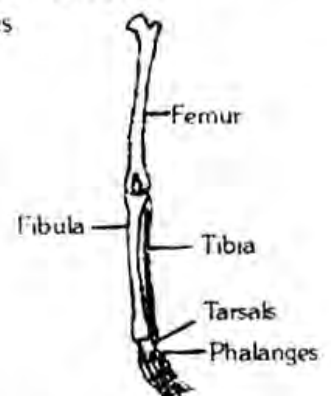

153. Electroporation procedure involves :

- (1) purification of saline water with the help of a membrane system
- (2) making transient pores in the cell membrane to introduce gene constructs
- (3) fast passage of food through sieve pores in phloem elements with the help of electric stimulation
- (4) opening of stomatal pores during night by artificial length

154. Somaclonal variation appears in

- (1) organisms produced through somatic hybridisation
- (2) plants growing in highly polluted conditions
- (3) apomictic plants
- (4) tissues culture raised plants

155. In an experiment freshly hatched larvae of an insect (Khapra beetle) were reared on a basal diet (complete diet without cholesterol) with increasing amounts of cholesterol. Results obtained are shown in the graph given in the below. The graph given indicates that :

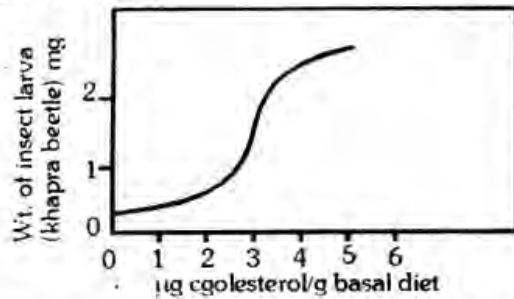

- (1) growth of khapra beetle is inhibited when cholesterol concentration exceeds $5 \mu\text{g/g}$ diet
- (2) cholesterol is an essential dietary requirement of khapra beetle
- (3) growth of khapra beetle is directly proportional to cholesterol concentration
- (4) cholesterol concentration of $2 \mu\text{g/g}$ diet is the optimum level

156. Which one of the following is correct matching of a plant, its habit and the forest type where it normally occurs ?

- (1) Acacia catechu, tree coniferous forest
- (2) Shorea robusta, herb, tropical rain forest
- (3) Prosopis, tree scrub
- (4) Saccharum, grass forest

157. cDNA probes are copied from the messenger RNA molecules with the help of

- (1) DNA polymerase (2) restriction enzymes
- (3) adenosine deaminase
- (4) reverse transcriptase

158. Gibberellins can promote seed germination because of their influence on

- (1) rate of cell division
- (2) synthesis of abscisic acid
- (3) production of hydrolyzing enzymes
- (4) absorption of water through hard seed coat

159. Which one of the following features is common in silverfish, scorpion, dragonfly and prawn ?

- (1) Cephalothorax and tracheae
- (2) Jointed appendages and chitinous exoskeleton
- (3) Three pairs of legs and segmented body
- (4) Chitinous cuticle and two pairs of antennae

160. Double fertilization involves

- (1) fertilisation of the egg and the central cell by two sperms brought by the same pollen tube

- (2) fertilization of two eggs in the same embryo sac by two sperms brought by one pollen tube
- (3) fertilization of the egg by two male gametes
- (4) fertilization of the egg and the central cell by two sperms brought by different pollen tubes

§ Directions for questions 161 – 180 : In each of the following questions, a statement of Assertion (A) is given followed by a corresponding statements of Reason (R) just below it. Of the statements, mark the correct answer as

- (1) If both assertion and reason are true and reason is the correct explanation of assertion
- (2) If both assertion and reason are true but reason is not the correct explanation of assertion
- (3) If assertion is true but reason is false
- (4) If both assertion and reason are false

161. Assertion : Senescence is the time when age associated defects are manifested.

Reason : Certain genes may be undergoing sequential switching on and off during one's life.

162. Assertion : In recombinant DNA technology, human genes are often transferred into bacteria (prokaryotes) or yeast (eukaryote).

Reason : Both bacteria and yeast multiply very fast to form huge populations which express the desired gene.

163. Assertion : Methane component of green house gases contributing to global warming is about 20 percent.

Reason : Introduction of multi-point fuel injection engines in automobiles has decreased methane content in the exhausts.

164. Assertion : Suspended particulate matter (SPM) is an important pollutant released by diesel vehicles.

Reason : Catalytic converters greatly reduce pollution caused by automobiles

165. Assertion : Interferons are a type of antibodies produced by body cells infected by bacteria

Reason : Interferons stimulate inflammation at the site of injury

166. Assertion : Organ transplantation patients are given immunosuppressive drugs

Reason : Transplanted tissue has antigens which stimulate the specific immune response of the recipient

167. Assertion : Persons suffering from haemophilia fail to produce blood clotting factor VIII

Reason : Prothrombin producing platelets in such persons are found in very low concentration

168. Assertion : In humans, the gamete contributed by the male determines whether the child produced will be male or female

Reason : Sex in humans is a polygenic trait depending upon a cumulative effect of some genes on X-chromosome and some Y-chromosome

169. Assertion : Mitochondria and chloroplasts are semiautonomous organelles

Reason : They are formed by division of pre-existing organelles as well as contain DNA but lack protein synthesizing machinery.

170. Assertion : Replication and transcription occur in the nucleus but translation occurs in the cytoplasm

Reason : mRNA is transferred from the nucleus into the cytoplasm where ribosomes and amino acids are available for protein synthesis

171. Assertion : The fungi are widespread in distribution and they even live on or inside other plants and animals

Reason : Fungi are able to grow anywhere on land, water or on other organisms because they have a variety of pigments, including chlorophyll, carotenoids, fucoxanthin and phycoerythrin

172. Assertion : C_4 photosynthetic pathway is more efficient than the C_3 pathway

Reason : Photorespiration is suppressed in C_4 plants.

173. Assertion : Presently the global atmosphere is warming up.

Reason : The depletion of stratospheric ozone layer has resulted in increase in ultraviolet radiations reaching the earth.

174. Assertion : Human ancestors never used their tails and so the tail expressing gene has disappeared in them.

Reason : Lamarck's theory of evolution is popularly called theory continuity of germ plasm

175. Assertion : Comparative biochemistry provides a strong evidence in favour of common ancestry of living beings

Reason : Genetic code is universal

176. Assertion : Darwin's finches show a variety of beaks suited for eating large seeds, flying insects and cactus seeds

Reason : Ancestral seed-eating stock of Darwin's finches radiated out from South American mainland to different geographical areas of the Galapagos Islands, where they found competitor-free new habitats.

177. The atmospheric concentration of CO_2 at which photosynthesis just compensates for respiration is referred to as CO_2 compensation point.

Reason : The CO_2 compensation point is reached when the amount of CO_2 uptake is less than heat generated through respiration because the level of CO_2 in the atmosphere is more than that required for achieving CO_2 compensation point.

178. Assertion : The age-sex structure of human population in countries like France and Germany gives a steep pyramid.

Reason : In countries like Sudan and India the population is increasing at a rapid rate.

179. Assertion : The duck-billed Platypus and the spiny ant-eater, both are egg-laying animals yet they are grouped under mammals.

Reason : Both of them have seven cervical vertebrae and 12 pairs of cranial nerves

180 Assertion : *Agrobacterium tumefaciens* is popular in genetic engineering because this bacterium is associated with the roots of all cereal and pulse crops

Reason : A gene incorporated in the bacterial chromosomal genome gets automatically transferred to the crop with which the bacterium is associated

General Knowledge

181. Metaphysics refers to :

- (1) Analysis of human body at atomic level
- (2) A branch of philosophy concerned with the rational query of reality
- (3) A branch of physics concerned with investigation of reality
- (4) Meta-analysis of physics for the purpose of theory of relativity

182. Who is called as numismatist ?

- (1) An expert on mathematics
- (2) An expert on numerology
- (3) A person who studies coins
- (4) A numerator

183. Anjali Bhagwat is related to which field :

- (1) Athletics
- (2) Lawn tennis

- (3) Badminton (4) Shooting
- 184. Who received Stains International award for Religion Harmony ?**
 (1) Bharatiya Vidya Bhavan
 (2) Pope John Paul
 (3) Teesta Setalvad (4) Kuldeep Nayar
- 185. A 'dirty' nuclear bomb means :**
 (1) It involves low grade fission reaction
 (2) It has small amount of cobalt 60
 (3) It involves small Ce - 137
 (4) It involves low grade fusion reaction
- 186. National Inland Navigation Institute (NINI) is situated in :**
 (1) Goa (2) Kolkata
 (3) Gomukh, Uttranchal
 (4) Patna
- 187. 'Blogs' means :**
 (1) Big logs used to cross the river in hills
 (2) On line journals where cyber -diarists unweave their stories
 (3) Big blocks of land used for grazing animals
 (4) Black spots in somebody's life
- 188. What is the colour of Black Box, that is found in aircraft ?**
 (1) Blue (2) Black
 (3) Orange (4) Red
- 189. Which author was a Bengali writer and an Oscar-winning film director ?**
 (1) Chhabi Biswas
 (2) Bankimchandra Chatterjee
 (3) Rabindranath Tagore
 (4) Satyajit Ray
- 190. What is the symbol of Laloo Prasad Yadav's RJD party ?**
 (1) Palm (2) Lantern
 (3) Tea Leaves (4) Elephant
- 191. Where is the Tibetan government-in-exile based ?**
 (1) London (2) Delhi
 (3) Dharamsala (4) Phomphenh
- 192. What is true of Leonardo da Vinci's Mona Lisa ?**
 (1) He dreamt her in the night
 (2) He painted without a model
 (3) The model was unmarried women
 (4) The model was the wife of client
- 193. Which is the annual pilgrimage that every Muslims should make once in the lifetime ?**
 (1) Jihad (2) Zakat
 (3) Haj (4) Sharhah
- 194. What is the term used in e-mail and on-line conversations to convey mood along with the words ?**
 (1) Emoticon (2) Flames
 (3) Smiley (4) Pictures
- 195. Whose quote is " I hear and I forget. I see and I remember. I do and I understand" ?**
 (1) Mickey Mantle (2) Confucious
 (3) Arthur Schopenhauer
 (4) Caskie Stinnet
- 196. Whose autobiography is 'Sunny Day's' ?**
 (1) Sunil Shetty (2) Sunny Deol
 (3) Sunil Gavaskar (4) Geoffrey Boycott
- 197. Which age in Indian history is referred to as the "Golden Age" ?**
 (1) Ancient (2) Mughal
 (3) Mayura (4) Gupta
- 198. Which novel of Amitav Ghosh is called Esteremi Orient in its Italian version ?**
 (1) The Circle of Reason
 (2) In An Antique Land
 (3) The shadow lines
 (4) Dancing in Cambodia
- 199. Which of the following is President A. P. J. Abdul Kalam's autobiography ?**
 (1) Crossroads
 (2) My Experiment with Truth
 (3) Wings of Fire
 (4) Ignited Minds: Unleashing the Power
- 200. Which of the following units of measurement is not named after a person ?**
 (1) Apgar (2) Barleycorn
 (3) Curie (4) Hertz

Answers

- 1.(4) 2.(1) 3.(3) 4.(3) 5.(2) 6.(2) 7.(2) 8.(4) 9.(2) 10.(1) 11.(1) 12.(1) 13.(1) 14.(1)
15.(3) 16.(3) 17.(3) 18.(4) 19.(3) 20.(2) 21.(3) 22.(3) 23.(3) 24.(3) 25.(4) 26.(4)
27.(4) 28.(2) 29.(2) 30.(4) 31.(3) 32.(1) 33.(4) 34.(4) 35.(4) 36.(4) 37.(4) 38.(4)
39.(4) 40.(3) 41.(1) 42.(4) 43.(3) 44.(2) 45.(2) 46.(1) 47.(3) 48.(4) 49.(4) 50.(1)
51.(1) 52.(1) 53.(1) 54.(3) 55.(1) 56.(3) 57.(1) 58.(1) 59.(2) 60.(1)
61.(4) 62.(3) 63.(2) 64.(1) 65.(1) 66.(1) 67.(1) 68.(2) 69.(2) 70.(4) 71.(2) 72.(3)
73.(2) 74.(2) 75.(1) 76.(4) 77.(4) 78.(2) 79.(2) 80.(4) 81.(4) 82.(4) 83.(4) 84.(1)
85.(2) 86.(4) 87.(1) 88.(1) 89.(2) 90.(1) 91.(3) 92.(1) 93.(1) 94.(1) 95.(1) 96.(1)
97.(4) 98.(3) 99.(3) 100.(1) 101.(2) 102.(1) 103.(2) 104.(2) 105.(3) 106.(4)
107.(3) 108.(1) 109.(1) 110.(4) 111.(4) 112.(1) 113.(1) 114.(4) 115.(4) 116.(2)
117.(3) 118.(4) 119.(1) 120.(1)
121.(2) 122.(4) 123.(3) 124.(3) 125.(2) 126.(1) 127.(2) 128.(4) 129.(4) 130.(2)
131.(4) 132.(1) 133.(3) 134.(2) 135.(2) 136.(1) 137.(4) 138.(4) 139.(2) 140.(2)
141.(3) 142.(1) 143.(4) 144.(2) 145.(2) 146.(2) 147.(4) 148.(3) 149.(1) 150.(4)
151.(2) 152.(1) 153.(2) 154.(4) 155.(2) 156.(3) 157.(4) 158.(3) 159.(2) 160.(1)
161.(1) 162.(1) 163.(2) 164.(2) 165.(4) 166.(1) 167.(3) 168.(3) 169.(3) 170.(1)
171.(3) 172.(1) 173.(2) 174.(4) 175.(2) 176.(1) 177.(3) 178.(2) 179.(2) 180.(1)
181.(3) 182.(3) 183.(1,4) 184.(3) 185.(3,4) 186.(1,4) 187.(4) 188.(3) 189.(4)
190.(2) 191.(3) 192.(4) 193.(3) 194.(1) 195.(2) 196.(3) 197.(4) 198.(1) 199.(3,4)
200.(2)

Hints and Explanations

PHYSICS

- 1.(4) For sky wave propagation the critical frequency is given by $f_c = 9 (N_{\max})^{1/2}$

Where N is the electron density / m^3

So for $f_c = 10 \text{ MHz}$

$$N_{\max} = \left(\frac{10 \times 10^6}{9} \right)^2 \approx 1.2 \times 10^{12} \text{ m}^{-3}$$

- 2.(1) NAND gate is the most preferred gate in logic gate circuits

- 3.(3) For the signal to remain inside the optical fibre, the minimum acceptance angle

$$\theta_{\min} = \sin^{-1} \sqrt{n_1^2 - n_2^2}$$

- 4.(3) Given the radius = 1 meter placed in a magnetic field of 0.01 tesla and frequency = 100Hz, then the induced emf = $\frac{\text{change in flux}}{\text{time}}$

$$\text{or induced emf} = \frac{2 \vec{B} \cdot \vec{A}}{T} = 2 BA \cos \theta f$$

$$= 2 \times 0.01 \times \pi \times 1 \times 1 \times 200$$

as $f = 200 \Rightarrow e = 4 \pi \text{ Volts}$

So the induced electric field

$$E = \frac{1}{2 \pi r} \left(\pi r^2 \frac{dB}{dt} \right)$$

$$= \frac{r}{2 \pi} \times e = \frac{4 \pi}{2 \pi} = 2 \text{ V/m}$$

- 5.(2) The current gain for an n-p-n transistor in common emitter configuration is given by

$$\beta = \frac{\Delta I_C}{\Delta I_B} \Big|_{I_E = \text{const.}}$$

$$\text{So } \Delta I_B = \frac{\Delta I_C}{\beta} = \frac{1 \times 10^{-3} \text{ Amp}}{100} = 1 \times 10^{-5} \text{ amp}$$

$$\text{So } \Delta I_E = \Delta I_C + \Delta I_B = 1 \times 10^{-3} + 0.01 \times 10^{-3} \text{ amp}$$

$$= (1.01) \times 10^{-3} \text{ amp}$$

- 6.(2) The focal length of objective lens is 200 cm and focal length of eye piece = 2 cm,

$$u = 2 \text{ km} = 2 \times 10^5 \text{ cm}$$

So using $\frac{1}{f} = \frac{1}{v} + \frac{1}{u}$ we get

$$\frac{1}{v} = \frac{1}{f} - \frac{1}{u} = \frac{u-f}{uf}$$

$$= \frac{2 \times 10^5 \times 200}{2 \times 10^5 - 2 \times 10^2}$$

$$= \frac{2 \times 10^2 \times 2 \times 10^5}{2 \times 10^2 [1000 - 1]} = \frac{2 \times 10^5}{999}$$

So magnification

$$m = \left| \frac{v}{u} \right| = \frac{2 \times 10^5}{999} \times \frac{1}{2 \times 10^5} = \frac{1}{50 \times 100}$$

So $l \approx 5 \text{ cm}$

- 7.(2) $E_0 = -13.6 \text{ eV}$

So Total energy = Kinetic energy + Potential energy

Potential energy = Total energy - Kinetic energy

= Total energy + Total energy

= 2 Total energy = -2 Kinetic energy

= $-2 \times 13.6 \text{ eV} = -27.2 \text{ eV}$

- 8.(4) The frequency (f) for X-rays varies as

$f \propto (Z - \sigma)^2$ where σ is the screening constant and is small ; $f \approx Z^2$

- 9.(2) The electric field due to $\sigma = \frac{\sigma}{2 \epsilon_0}$

The electric field due to $-\sigma = \frac{-\sigma}{2 \epsilon_0}$

So, the net electric field mid way between σ and $-\sigma$ is

$$\frac{\sigma}{2 \epsilon_0} - \left(\frac{-\sigma}{2 \epsilon_0} \right) = \frac{\sigma}{\epsilon_0} \text{ volt/metre}$$

- 10.(1) In a semiconducting material, the effective mass of a hole is more than that of an electron so the mobility of electron is more as compared to that of a hole.

- 11.(1) The magnetic moment of revolving electron is

given by $\vec{\mu} = \frac{e}{2m} \vec{L}$ and $L = \frac{n h}{2 \pi}$

$$\text{So } \mu = \frac{eh}{4\pi m} = \frac{eh}{2m} \times \frac{n}{2\pi} = \mu_B \frac{n}{2\pi}$$

Where μ_B = Bohr magneton. Thus $\mu \propto n$

- 12.(1) The half life of a radioactive material

$$T_{1/2} = 10 \text{ days} = \frac{0.693}{\lambda}$$

and $T = 30 \text{ days} = n T_{1/2}$

$$\text{So } n = \frac{30}{10} = 3$$

$$\text{Hence } \frac{N}{N_0} = \left(\frac{1}{2} \right)^n = \left(\frac{1}{2} \right)^3 = \frac{1}{8}$$

$$\text{Thus } N = \frac{N_0}{8}$$

So 1/8 of the initial mass would be left

13.(1) The red shift of a galaxy varies according to Hubble's law: $Z = H_0 r$ so $Z \propto r$

14.(1) When exposed to sunlight soap films exhibit a variety of brilliant colours due to the phenomenon of interference of light beams various portions of the soap film.

15.(3) Parsec measures the distance between celestial bodies.

16.(3) The voltage gain of the amplifier is

$$A_v = \frac{V_{out}}{V_{in}} = \frac{R_1}{R_{in}} = \frac{100 \text{ k}\Omega}{1 \text{ k}\Omega} = 100$$

17.(3) $f = 50 \text{ Hz}$, $V = 20 \text{ v}$, $V_R = 12 \text{ V}$

$$\text{Total voltage } V = \sqrt{V_R^2 + V_C^2}$$

$$\text{So, } 20 = 12 + V_C^2 \text{ or } V_C^2 = 256 \text{ So, } V_C = 16$$

18.(4) The intensity is defined as energy per unit time per unit area and pressure is force per unit area.

$$\text{So Intensity } I = \frac{F \cdot S}{A t} = \frac{F c}{A} = P c \text{ so } P = I/c$$

19.(3) mass = 0.1 kg

impulse = Change in momentum

$$= m \Delta v$$

$$= \frac{m \Delta x}{\Delta t} = 0.1 \times \frac{4 - 0}{2 - 0} = 0.2 \text{ kgm/sec}$$

20.(2) mass = 10 kg, speed = 10 m/sec

$$F = -0.1 \times \text{joule/metre}$$

Then the work energy theory states

$$w = \Delta K \cdot E \Rightarrow w = \frac{1}{2} m v_2^2 - \frac{1}{2} m v_1^2$$

$$\int_{20 \text{ m}}^{30 \text{ m}} F \cdot dx = w = K \cdot E_{final} - \frac{1}{2} \times 10 \times 10^2$$

$$\text{So } -0.1 \int_{20}^{30} x dx = K \cdot E_{final} - \frac{1}{2} \times 10 \times 100$$

$$\Rightarrow -0.1 \left(\frac{x^2}{2} \right) \Big|_{20}^{30} = K \cdot E_{final} - 500$$

$$\Rightarrow \frac{-0.1}{2} (900 - 400) = K \cdot E_{final} - 500$$

$$\Rightarrow \frac{-0.1}{2} \times 500 = K \cdot E_{final} - 500$$

$$\Rightarrow -25 = K \cdot E_{final} - 500$$

$$\Rightarrow K \cdot E_{final} = 500 - 25 = 475 \text{ joules}$$

21.(3)

22.(3) The given mass = m, radius = r

for this star of mass m to be a black hole

$$\frac{G m}{c^2 r} \geq \frac{1}{2} \text{ or } \sqrt{\frac{2 G m}{r}} \geq c$$

23.(3) Glass is an amorphous solid

24.(3) The bulk modulus is given by

$$B \propto \frac{1}{\Delta V/V} \text{ or } B \propto \frac{V}{\Delta V}$$

25.(4) For a function y to represents a simple harmonic motion,

$$\frac{d^2 y}{dt^2} + \omega^2 y = 0$$

for $y = \sin \omega t - \cos \omega t$

$$\frac{dy}{dt} = \omega \cos \omega t + \omega \sin \omega t$$

$$\frac{d^2 y}{dt^2} = -\omega^2 \sin \omega t + \omega^2 \cos \omega t = -\omega^2 y$$

Thus y represents a simple harmonic motion

26.(4) For a linearly polarised light, the magnitude of electric field vector varies in a periodic fashion with time.

27.(4) The circuit shown is a filter whose output current, voltage and frequency can be tuned by varying the capacitance and inductance.

28.(2) R_2 and R_3 are parallel, so the voltage across them are equal, so for the dissipation of same energy in R_2 and R_3 , $R_2 = R_3$. Now using Kirchoff's law, we get $i_1^2 R_2 t = i^2 R_1 t$, where i_1 is the current through R_2 and i is the current through R_1 .

$$\text{and } i_1 = \frac{R_3}{R_2 + R_3} i = \frac{R_3}{R_3 + R_3} i = \frac{i}{2}$$

$$\text{So we get } R_1 = \frac{R_2}{4}$$

29.(2) Given that the apparent depth of water is decreasing from the tank of diameter 2R cm

$$\text{Then } \frac{n_2}{n_1} = \frac{\text{real depth}}{\text{apparent depth}} = \frac{dr}{da}$$

$$\text{or } \frac{n_2}{n_1} = \frac{d(dr)/dt}{d(da)/dt}$$

So change in real depth

$$= \frac{n_2}{n_1} \times \text{change in apparent depth}$$

$$\frac{d(da)}{dt} = \frac{n_2}{n_1} \times x \text{ cm/min}$$

So the amount of water drained in c. c per minute

$$= \frac{d(da)}{dt} \times \pi R^2 = x \pi R^2 \frac{n_2}{n_1}$$

- 30.(4) The weight of the liquid displaced would be equal to the weight of the candle

So $\rho_L \times \text{volume of liquid displaced} \times g$

$$= \rho_c V_c g$$

$$\Rightarrow \rho_L \times \frac{\pi d^2}{2} L g = \rho_c \pi \left(\frac{d}{2}\right)^2 2L$$

$$\Rightarrow \frac{\rho_c}{\rho_L} = \frac{1}{2}$$

When 2 cm of the candle is burnt, the total length decreases to $2L - 2$ and $\rho_L (2L - 2) = \rho_L (L - x)$

So $x = 1$ cm

Thus when the length of the candle decreases by 2 cm, both above the liquid and below the liquid, there is a decrease of 1 cm.

- 31.(3) When the complete set up shown is rotated with an angular velocity ω then the net pressure acting

on A tube = atm pressure + $h_1 \rho g + \frac{A \rho \omega^2}{A} \times \frac{L^2}{2}$

and the net pressure at B = atm pressure + $h_2 \rho g$

$$\text{So } h_2 - h_1 = \frac{\omega^2 L^2}{2g}$$

Since ω is same.

$$\text{So } L_2 > L_1, h_2 > h_1$$

So both of the heights will increase.

- 32.(1) Given the velocity = v_0 , the ball reaches h so

$$\text{from } v^2 = u^2 + 2as, u^2 \propto s = h$$

$$\text{and so } u'^2 \propto 3s \therefore u' = \sqrt{3} v_0$$

- 33.(4) From the conservation of energy, potential energy = translational kinetic energy + rotational kinetic energy

$$\text{or } mgh = \frac{1}{2} m v^2 + \frac{1}{2} \times \left(\frac{2}{5}\right) mR^2 \cdot \frac{v^2}{R^2}$$

$$\text{So } mgh = \frac{7}{10} m v^2$$

$$\text{or } v^2 = \frac{10}{7} gh$$

$$\text{So } v = \sqrt{\frac{10gh}{7}} \text{ or } v \geq \sqrt{\frac{10gh}{7}}$$

- 34.(4) When a viscous fluid of mass m is dropped at the centre and it starts spreading, its moment of inertia increases and thus angular velocity decreases. When it starts falling, then its moment of inertia

starts to decrease again and its angular velocity increases.

- 35.(4) The C.M falls vertically downwards

- 36.(4) When the elevation moves with an acceleration $a = g$ downwards, he feels weightless.

- 37.(4) On the boundary of shell A, potential is same, it decreases as $V_A \propto 1/s$ and then goes to -ve on the shell B.

- 38.(4) When the north pole approaches current starts flowing in the coil in the anticlockwise direction and emf increases after passing the coil, the emf drops to zero. After the magnet comes towards the coil again, the emf starts to increase in the reverse direction but after a delay.

- 39.(4) The resistance is given by

$$R = \frac{V}{I} = \frac{ML^2 T^{-3} A^{-1}}{A} \\ = ML^2 T^{-3} A^{-2}$$

- 40.(3) The negative charge placed at a distance z away oscillates and the resulting force acts as a restoring force and the displacement it makes is proportional to $\cos \theta$ and the displacement is always z -axis

- 41.(1) The relative density or specific gravity is the density of any substance divided by the density of water so the specific gravity

$$= \frac{\text{density of substance}}{\text{density of water}} = \text{dimensionless quantity}$$

- 42.(4) The loss due to frictional force cannot be recovered and hence this force is known as non conservative force

- 43.(3) The transparency of an optical substance is the ease with which the light can pass through the optical substance. If the surface is rough, its transparency will be less

- 44.(2) Diode lasers are used in optical communications to generate digital signals for transmission through optical fibre cables, they are used because they are easy to handle and consume less energy.

- 45.(2) The glittering property of diamond is due to the light which suffers multiple total internal reflecting and the light which enters once cannot go out of it and is trapped inside

- 46.(1) The energy E and momentum p are related for a photon by the De Broglie relation

$$\lambda = \frac{h}{p}, \text{ and } E = \frac{hc}{\lambda} = \frac{hc}{h} p = pc$$

$$\text{So, } p = E/c$$

47.(3) The clouds in the sky consist of dust particle and water vapour which have size much larger than the wavelength the light which falls on them, since the difference in wavelength is larger, so there is no scattering and we receive white light

48.(4) The ionosphere reflects back the frequency which is less than the critical frequency (30 MHz) but absorbs frequencies higher than 30 MHz. So television frequencies higher than 30 MHz won't come back to earth.

49.(4) A diode cannot be used to build a NOT gate as the output frequency of diode is in same phase with the input and hence NOT gate cannot be built.

50.(1) Resolving power of a telescope varies as $R \propto D$ where D is diameter (as $R = \frac{D}{1.22 \lambda}$), thus more the diameter more is the resolving power.

51. (1) We cannot make any system which is free of all kinds of dissipative forces like where there is no loss due to friction or heat.

52.(1) The angular momentum is given by

$$L = I\omega = \text{constant}$$

Then $\tau = I\alpha = 0$, so the torque acting on the system is zero and hence the force is a central force as $F \times r = 0$

53.(1) Since the process occurs very quickly, this is an adiabatic process, so the leaking air becomes cooler.

54.(3) ^{35}Cl has a large binding energy, and for the nuclear fusion to take place, the binding energy should be less.

55.(1) The no. of electrons in a p-type semiconductor is less as compared to that in pure silicon semiconductor because in pure silicon the no. of electrons = no. of holes = $n = n_i = n_h$ (for p type).

Since $n_h > n_p$ in p-type so $n_i = \frac{n}{n_h} < n_i$

56.(3) In common emitter amplifier, the input impedance is not very high, it is less than that of common base configuration

57.(1) Kirchoff's law states that absorptivity of a material equal to its emissivity i. e if a material is a good observer, its emissivity will also be high.

58.(1) The negative slope of the melting curve in a P-T phase diagram is because liquids contract when they melt.

59.(2) The emission wavelength follows the Wien's displacement law given by $\lambda_m T = b = \text{const}$. So when T is higher, λ will shift towards the lower side.

60.(1) For $R_v > 2000$ the flow of fluid is turbulent because the ratio of inertia of the fluid in motion per unit area and force per unit area is very high so the inertial force dominates viscous force.

CHEMISTRY

61.(4) All these three molecules

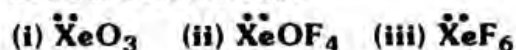

have one lone pair of electron. It is clear from the structure

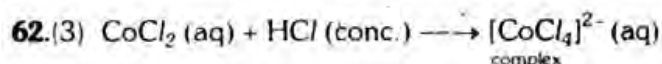
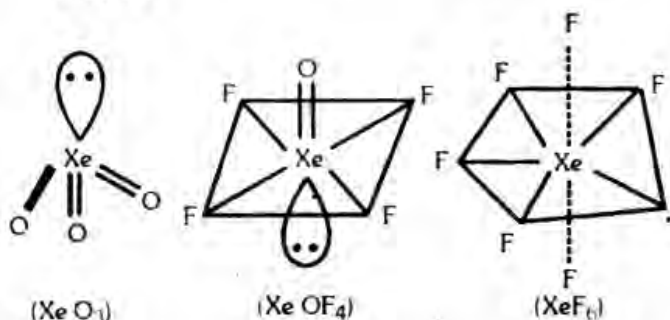

Here in this reaction CoCl_2 acts as weak Lewis acid which reacts with conc. HCl gives $[\text{CoCl}_4]^{2-}$ ion. CoCl_2 generally used as indicator in water because anhydrous CoCl_2 is deep blue in colour but it turns magenta in colour when hydrated.

63. (2) The complex $[\text{Co}(\text{en})_3]\text{Cl}_3$

cis $[\text{Co}(\text{en})_2\text{Cl}_2]\text{Cl}$ will show optical isomerism

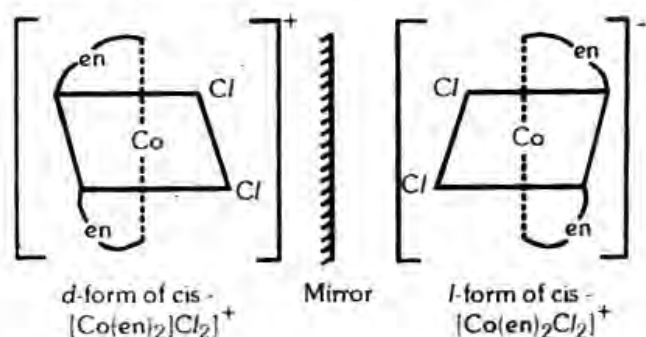
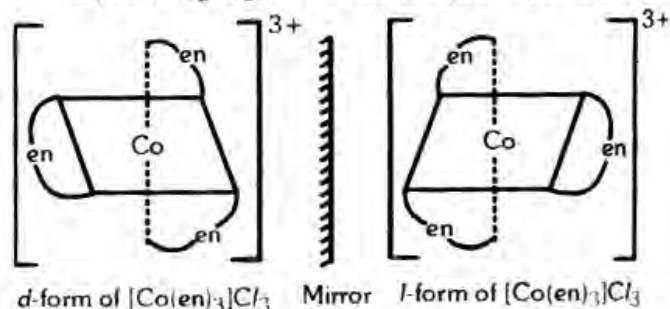

64. (1) CN^- is strong ligand which causes stronger splitting and leads to pairing up of electrons. Due to the pairing of all available electron of Ni^{2+} the complex compound shows diamagnetism.

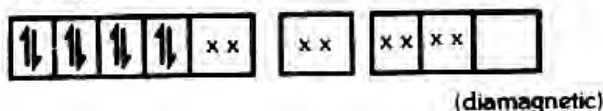
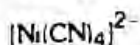

But Cl^- and F^- is weak ligand which is not capable to pair up all the unpaired electron of Ni^{2+} and Co^{2+} .

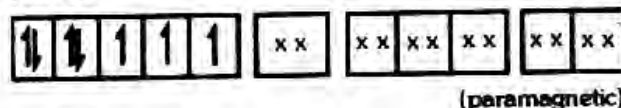
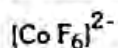
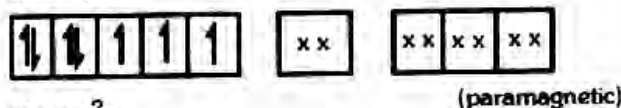
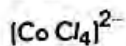
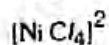

65. (1) $\text{IO}_3^- + a \text{I}^- + b \text{H}^+ \longrightarrow \text{CH}_2\text{O} + d \text{I}_2$
 or, $\text{I O}_3^- + 5 \text{I}^- + 6 \text{H}^+ \longrightarrow 3 \text{H}_2\text{O} + 3 \text{I}_2$
 Therefore, a, b, c and d are respectively 5, 6, 3 and 3.

66. (1) +1 oxidation state of Tl is more stable than +3 oxidation state of Tl and thus Tl^{3+} converts in to Tl^+ ion causes oxidation to others (oxidising agent).



67. (1) In the phosphorous pentoxide and phosphorous trioxide structure the number of P - O - P bridges are 6, 6 respectively. It can be seen in the structure

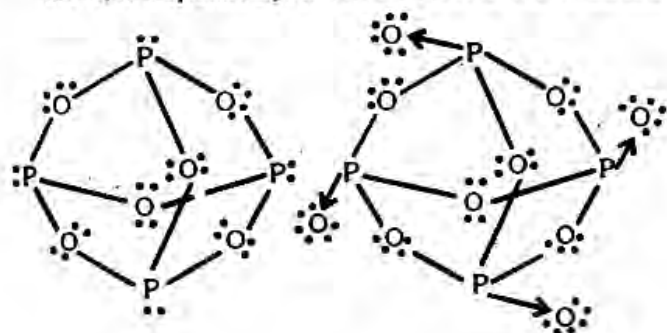

68. (2) The two bond angles of diborane are nearly 95° and 120°

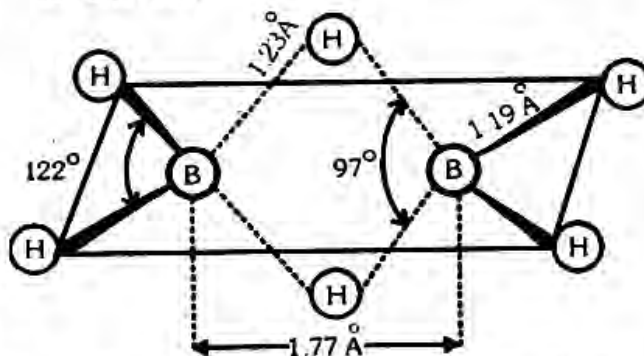

69. (2) On the hydrolysis of magnesium carbide propyne can be obtained



70. (4) The hydroxide of berilium and zinc are amphoteric in nature. It can reacts with base as well as acids.

71. (2) Malachite is carbonate ore its formula is $\text{CuCO}_3 \cdot \text{Cu}(\text{OH})_2$, pyrolusite is MnO_2 , diaspore is $\text{Al}_2\text{O}_3 \cdot \text{H}_2\text{O}$ and cassiterite is SnO_2 .

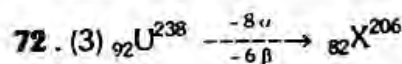

$$\text{N} \cdot \text{P} \text{ ratio} = \frac{124}{82} = \frac{62}{41}$$

73. (2) The correct order for the wavelength of absorption in the visible region is

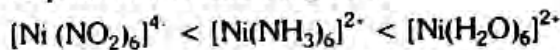

The absorption of energy in co-ordination compounds depends on charge on complex ion and nature of ligand. Weak ligand associated with absorption of higher wavelength. H_2O is weaker ligand among the given complex and NO_2 is stronger ligand.

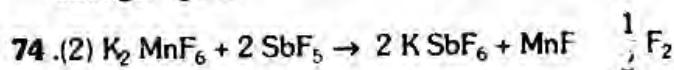

75. (1) The No. of electrons in ClO_2^-
 $= 7 + 6 + 6 + 1 = 20$

The No. of electrons in $\text{ClF}_2^+ = 7 + 7 + 7 - 1 = 20$

76. (4) Industrial method to prepare isocyanate is

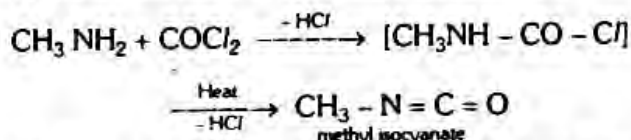

77. (4) Zinc sulphide (ZnS) is a compound which have phosphorescence. When α - particle strikes on

ZnS it illuminates and thus α - particle can be detected.

78 .(2) The compound

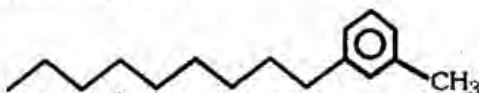

is completely non polar and it will disperse in non polar benzene completely. Other compounds are partly or completely polar which cannot disperse in benzene as benzene is non-polar.

79 .(2) For the reaction



The cell representation will be

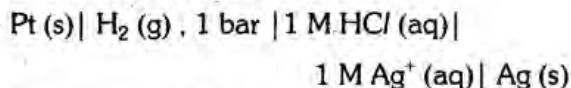

80 .(4) The number of tetrahedral void per unit cell is double of the number of the atom i. e., No. of tetrahedral void = $2 \times$ No. of atoms

$$\text{or, No. of tetrahedral void} = 2 \times Z = 2Z$$

81 .(4) The standard enthalpy of formation, ΔH_f° is heat of reaction when one mole of that substance formed from its element of most stable isotopes. Graphite is most stable isotope of carbon therefore, the ΔH_f° of CH_3OH will be

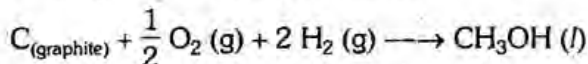

82 .(4) If the energy of product is more than energy of reactant it is said to be endothermic reaction

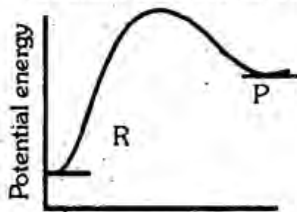

Reaction coordinate.
Endothermic reaction
with high activation
energy

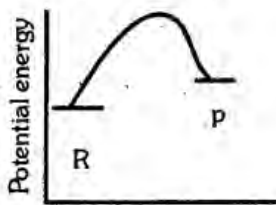

Reaction coordinate.
Endothermic reaction
with low activation
energy

83 .(4) $\text{pK}_a = -\log K_a$, $\text{pK}_b = -\log K_b$

$$\text{pH} = -\frac{1}{2} [\log K_a + \log K_w - \log K_b]$$

$$= -\frac{1}{2} [-5 + \log (1 \times 10^{-14}) - (-5)]$$

$$= -\frac{1}{2} [-5 - 14 + 5] = -\frac{1}{2} (-14) = 7$$

84 .(1) Most probable radius = $\frac{a_0}{Z}$

{where, $a_0 = 52.9 \text{ pm}$, $Z = 2$ (for helium ion)}

$$r_{\text{mp}} = \frac{52.9}{2} = 26.45 \text{ pm}$$

85 .(2) In a sealed bomb calorimeter no compression or expansion is possible because of fixed volume therefore, $w = 0$ and $\Delta U = q$

$$\text{So, } \Delta U < 0, w = 0$$

86 .(4) For the reaction



$$\text{Rate of the reaction} = [\text{A}]^a$$

$$\text{Order of the reaction} = a$$

$$[\text{A}]_1 = 2.2 \text{ m M}, r_1 = 2.4 \text{ m M s}^{-1} \quad \dots (1)$$

$$[\text{A}]_2 = \frac{2.2}{2} \text{ m M}, r_2 = 0.6 \text{ m M s}^{-1} \quad \dots (2)$$

If $[\text{A}]$ is reduced to $\frac{1}{2}$, the rate of reaction de-

creased by $\frac{1}{4}$ times

$$\text{Rate of reaction} = [\text{A}]^2$$

$$\text{Order of reaction} = 2$$

87 .(1) For the reaction

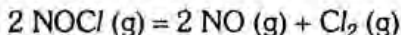

$$K_p = K_c (RT)^{\Delta n}$$

$$K_p = 3 \times 10^{-6} (0.0821 \times 700)$$

$$= 172.41 \times 10^{-6} = 1.72 \times 10^{-4}$$

88 .(1) For the reaction



$$K_p = p\text{CO}_2 \text{ and } K_c = [\text{CO}_2]$$

(since $[\text{CaCO}_3] = 1$ and $[\text{CaO}] = 1$ for solids)

From Arrhenius equation

$$K = A e^{-\Delta H_f^\circ / RT}$$

On taking logarithm

$$\log K_p = \log A - \frac{\Delta H_f^\circ}{RT (2.303)}$$

Graphically

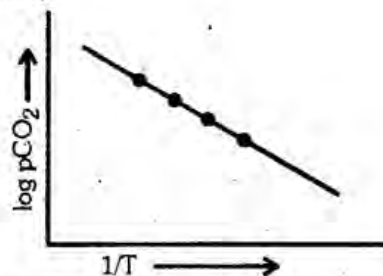

Equation for straight line ; $Y = m x + C$

$$\text{Here, } \log K_p = -\frac{\Delta H_1^\circ}{2.303} \left(\frac{1}{T} \right) + \log A$$

Y m x C

89.(2) C_2H_5SH is strong nucleophile among given choice. Nucleophile are those compounds or species which can donate a pair of electrons. Nucleophile can be neutral compound or negative ions and its strength depends upon its capacity to donate electron. Bulky alkyl group pumps electron more (+I effect) than smaller alkyl group. That is why ethyl group is better nucleophile than methyl group.

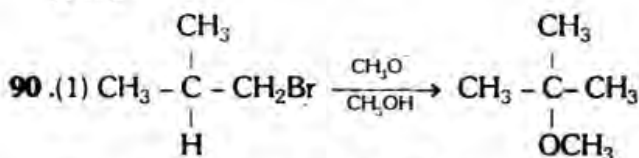

It carried out according to S_N2 reaction through an intermediate. The most stable carbocation is 3° carbonium ion.

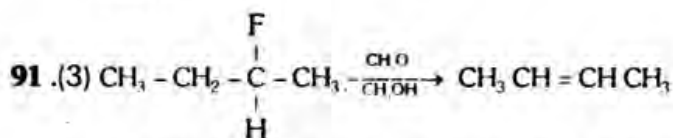
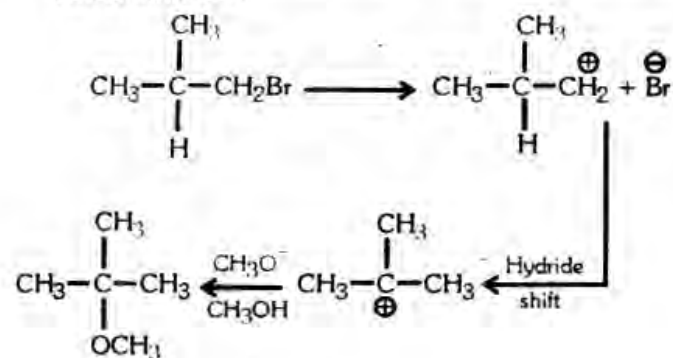

Highly substituted alkene are more stable and it is the major product (Saytzeff's rule)

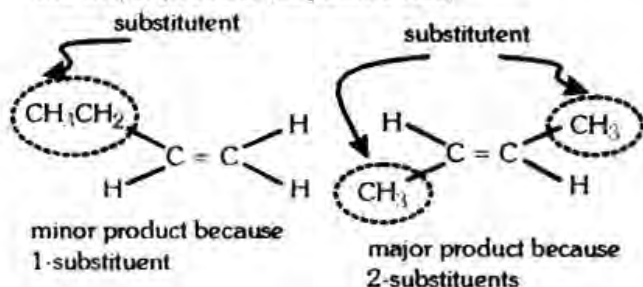

92.(1) The most stable compound among given choice is *trans*-1, 3-cyclohexanediol. It is due to the fact that the bulky group are apart and opposite side but in the *cis*-form bulky groups are at the same side which causes steric effect (repulsion)

and hence less stable whereas in the *trans*-form this repulsion is absent

93.(1) Markovnikov's rule suggests that negative part of the addendum goes to that doubly bonded carbon atom which has less number of hydrogen atom. Therefore, Br- will attach to 2° carbon atom.

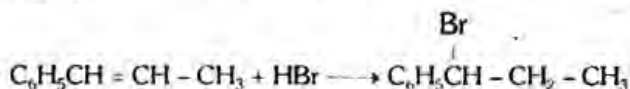

94.(1).

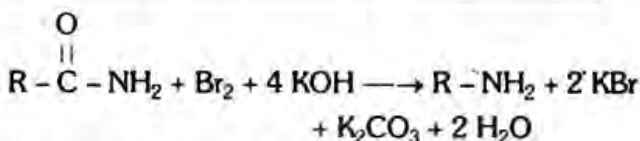
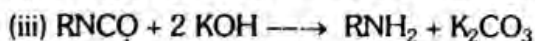
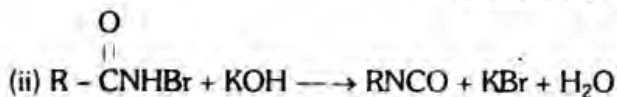
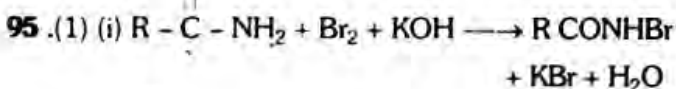
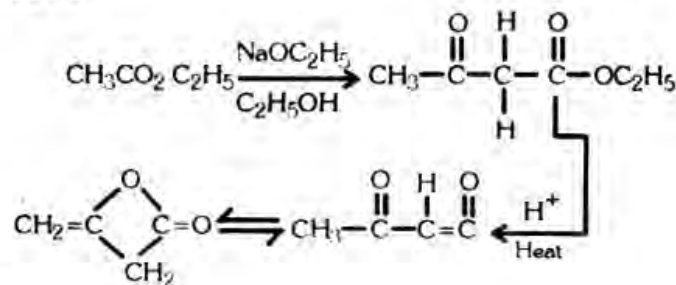

96.(1) Basic character of amine is due to availability of lone pair of electron. Triethyl amine contains lone pair of electrons as well as +I effect. The lone pair of electron of pyridine is delocalised and not available for protonation that is why pyridine is less basic than triethyl amine.

97.(4) α -Keratin is major constituent of hair, nails and skins, it is insoluble in water but soluble in some organic solvent. Strong acid and base also can dissolve α -Keratin.

98.(3) The correct configuration of the structure

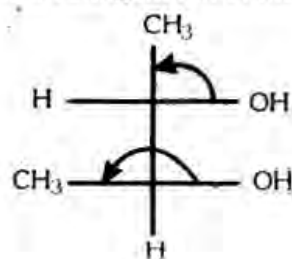

is 1S, 2S because it obeys the 'Golden Rule' and the lowest priority group (H) present in the vertical position to the below of the Fisher projection

- 99 .(3) All the amino acid except methionine and tryptophan are coded by more than 1 codon, for example, valine is specified by GUU, GUA, GUC, GUG. This shows that first two bases (G U) are common in all four codons coding for valine. But the third base can be changed

100 .(1)

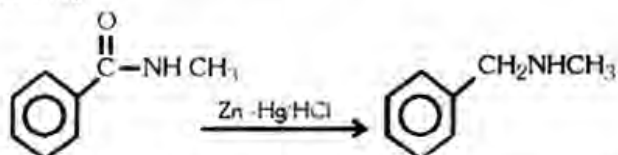

The above reaction is called Clemmenson reduction

- 101 .(2) Sulphur dioxide have both oxidizing as well as reducing property. The reaction explained in assertion is only oxidizing property of sulphur dioxide



- 102 .(1) Due to small size of fluorine SiF_6^{2-} exist because of less steric repulsion. The interaction of

lone pairs of :F: with d-orbital of Si is strong

- 103 .(2) Both assertion and reason are true but reason does not explains assertion. The correct reason for the fact that the Al (III) in both oxidizing as well as reducing flame is colourless therefore, not suitable for Borax bead test.

- 104 .(2) Reason is not correct explanation for assertion of course it is independently correct. Ozone can liberate nascent oxygen easily therefore, acts as powerful oxidizing agent.

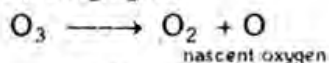

- 105 .(3) The crystal field splitting in ferrocyanide ion is less than that of ferricyanide ion, so reason is false. Potassium ferrocyanide does not contain any unpaired electron hence diamagnetic whereas potassium ferricyanide contains unpaired electron hence paramagnetic

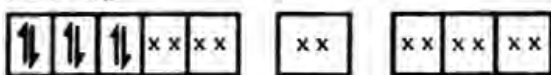
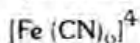

(diamagnetic)

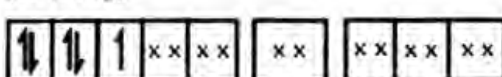
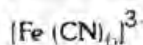

(paramagnetic)

- 106 .(4) Both assertion and reason are false, because $\text{Ba}(\text{OH})_2$ is soluble in water and it will not give precipitate.

- 107 .(3) It is true that SeCl_4 does not have tetrahedral structure, it possess see saw geometry. The shape can be regarded as a distorted bipyramidal structure, contains **one lone pair** of electron in basal position of the trigonal bipyramidal. According to this, the reason given in question is false.

- 108 .(1) Both assertion and reason are true and reason explains the assertion. Depression in freezing point is democratic or colligative property which depends upon the number of particles. Acetic acid ionises in water because of its polar nature and give Van't Hoff factor i more than 1 whereas acetic acid does not ionises in benzene and will give Van't Hoff factor $i = 1$. Due to this fact in both the liquid molecular weight of acetic acid will be different

- 109 .(1) Both assertion and reason are true and explains. The compressibility factor increases with pressure in the case of H_2 . At 273 K, $Z > 1$ which indicates that it is difficult to compress the gas as compared to ideal gas. Here repulsive force dominates.

- 110 .(4) Both assertion and reason are false, because 1st ionization energy for nitrogen (14.5 eV) is greater than oxygen (13.6 eV). This is due to the stable configuration of nitrogen i. e., half filled 2p-orbital.

- 111 .(4) Both assertion and reason are false because in B_2 , total number of electrons = 10.

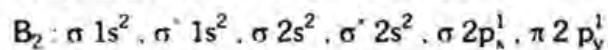

There are two unpaired electrons i. e., $\sigma 2p_x^1$ and $\pi 2p_y^1$ shows the paramagnetic character. The outer most orbital here is $\pi 2p_y^1$ therefore, this is the highest occupied orbital

- 112 .(1) Both assertion and reason are true and reason explains the assertion. The rate of hydrolysis of CH_3Cl to CH_3OH is higher in DMF than H_2O because hydrolysis of CH_3Cl follows second order kinetics

- 113 .(1) It is true that galvanized iron does not rust, it is because Zn metal has a more negative electrode potential than Fe hence Zn corrodes first. When all the Zn will corrode out (oxidized) then Fe will get corrode.

114.(4) Both assertion and reason are false. Extraction of Fe metal from its oxide ore is done by heating with coke and flux (CaCO_3). Here flux acts as slag forming substance. Flux converts infusible impurities into fusible slag. The reaction

$\text{Fe}_2\text{O}_3(\text{s}) \longrightarrow \text{Fe}(\text{s}) + 3/2 \text{O}_2(\text{g})$ is not a spontaneous process because it needs continuous heat to produce Fe.

115.(4) Nitration depends upon the concentration of electrophile or, in other words it depends on the availability of electrophile. That is why rates of nitration of benzene and hexadeutero benzene are same.

116.(2) If 3° alkyl halide is used in Williamson's synthesis ether will not form, it is because alkoxides are not only nucleophiles but also strong bases as well. They react with alkyl halide leads to formation of alkenes.

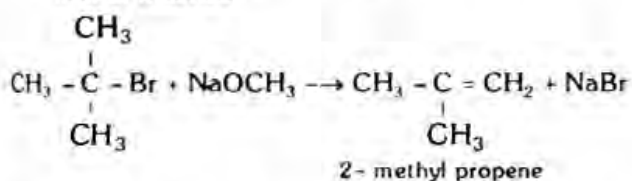

117.(3) It is true that maltose is reducing sugar and it gives 2 moles of D-glucose on hydrolysis. The two glucose units are linked through α -glucosidic linkage between C-1 of one glucose unit and C-4 of the other glucose unit.

118.(4) Both assertion and reason are false because $-\text{NO}_2$ group strongly deactivates the benzene ring towards electrophilic substitution. $\text{C}_6\text{H}_5 - \text{NO}_2$ does not undergoes electrophilic substitution

119.(1) Both assertion and reason are true and explains. Electrophile attacks on $\text{R} \overset{+}{\text{N}} \equiv \overset{-}{\text{C}}$ first then nucleophile attacks on it. After this rearrangement takes place.

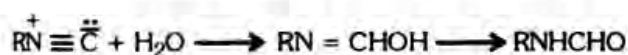
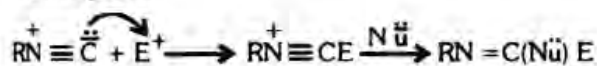

120.(1) Both assertion and reason are true and explains. Cyclopentadienyl anion is much more stable than allyl anion because it follows Hückel rule and hence aromatic in nature. It is resonance stabilized too.



Cyclopentadienyl anion resonance structure

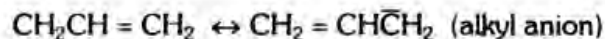

Stability also depends upon number of resonance structure. If number of resonance structure is more it is more stable.

BIOLOGY

121. (2) In *Morphallaxis* regeneration occurs through the repatterning of existing tissues and there is little new growth.

In *Hydra*, the cells of the body are constantly in mitosis and the cells are eventually displaced to the extremities of the body from which they are shed. Thus each cell gets to play its several roles depending on how old it is. If the *Hydra* body column is cut into several pieces, each piece will regenerate a head at its original apical end and a foot at its original basal end. No cell division is required for this to happen and the result is a small *Hydra*.

Planarians possess a tremendous power of regeneration. If cut across into two, three or more parts, each part regenerates into a complete and normal individual. It involves two complementary processes viz. epimorphosis, in which the missing parts are formed and morphallaxis, in which the original parts are fit to function with regenerated parts in the new individual.

122. (4) the atrial natriuretic factor (ANF) is a peptide released by the walls of the Atria of the Heart in response to an increase in blood volume and pressure. ANF inhibits the release of renin from Juxta glomerular Apparatus and thereby inhibits NaCl reabsorption by the collecting duct and reduces aldosterone release from adrenal gland

Gastrin is produced by G cells present in the pyloric glands of the stomach and in the first part of duodenum.

Inhibin is produced by Sertoli cells in males and granulosa cells in females. It inhibits FSH of anterior pituitary by direct action.

Enterokinase is present in the tip of duodenal epithelium in the brush border. It converts trypsinogen (proenzyme) into trypsin (the active enzyme).

123.(3) Thymus also called the 'throne of immunity' releases thymosin hormone which has a stimulating effect on the entire immune system. It pro-

moles proliferation and maturation of T-lymphocytes. The thymus reaches its maximum size at puberty and then atrophies

Cretinism is caused if severe hypothyroidism occurs in utero or in infancy its symptoms being irreversible mental retardation and impaired growth.

Parathyroid hormone stimulates the osteoclasts in the bone to dissolve the hydroxyapatite crystals of the bone matrix and release Ca^{2+} ions into the blood. The body sacrifices bone to keep blood Ca^{2+} levels within the limits necessary for proper functioning of muscle, nerve and endocrine tissue.

Delta cells synthesis somatostatin which inhibits secretion of glycogen and insulin thereby decreases motility and absorption in the digestive tract.

124. (3) The trait passes from Generation 1 to generation 2 from father to his daughter but not sons thereby proving that it is an X linked trait. Since the daughter gets another X chromosome from her mother who is unaffected, thus the trait is dominant X-linked. In third generation the only son who gets the trait is the one who inherits the dominant X-chromosome from mother whereas the other two sons who get the recessive X from mother are unaffected.

125.(2) Within the mid piece of a human sperm are a centriole, which acts as a basal body for the flagellum, and mitochondria, which generate the energy needed for flagellar movement. The tail consists of a central core comprising the axial filament with 9+2 micro tubular arrangement continuing from the mid piece. The centrioles are housed in a short neck that connects the head and mid-piece.

126.(1) The gene encoding hirudin was chemically synthesized and then transferred into the plant *Brassica napus* where hirudin accumulates in seeds.

Bt stands for *Bacillus thuringiensis* whose Bt-2 gene enclosing Bt toxin has been transferred into Bt-cotton for developing insect resistance.

Somatic hybridization involves only the fusion of protoplast of two cells.

In the transgenic tomato 'Flavr Savr' the production of polygalacturonase (which promotes fruit softening) was blocked hence giving tomatoes

which remain fresh and retain their flavour much longer than do the fruits of normal tomato varieties.

127.(2) Histamine, a chemical released by a variety of cells in response to tissue injury, binds to receptors on nearby capillaries and venules causing vasodilation and increased permeability.

Kinins are small peptides, normally present in blood plasma in an inactive form. Tissue injury activates these peptides which then cause vasodilation and increased permeability. A particular kinin called bradykinin, also stimulates pain receptors in skin, which normally causes an individual to protect the injured area.

128.(4) The western ghats lies parallel to the Western coast of India (1600 Km). The silent valley and the new Amambalam reserve are the two main centres of diversity.

The eastern Himalaya Hot Spot extends to the North eastern India and Bhutan. Many deep and Isolated Valleys found in this region are exceptionally rich in endemic plant species.

129.(4) Introduction of high yielding varieties will lead farmers to grow only high yielding crops as they will give more benefit. Hence over a period of time the existence low yielding but Genetically-diverse crops will be threatened

130.(2) *Ex situ* or off site conservation means maintaining individuals or their germ cells under artificial conditions. Examples for animals include zoos, gameparks, aquaria, captive breeding programs and germplasm banks (where their eggs and sperms are cryopreserved in liquid Nitrogen). Plants are maintained in botanical gardens, arboreta and seed banks.

In situ conservation means protecting the species in its natural habitat such as wild life sanctuaries, national parks or reserves.

131. (4) Nitrate fertilizers used on soil enter our wells and ponds. When water is taken by us nitrates are converted into nitrites by microbial flora of Intestine. The nitrites combine with the haemoglobin of blood to form methemoglobin, which interferes with the O_2 carrying capacity of the blood. The disease caused is called Methaemoglobinaemia. This causes damage to respiratory and vascular

system, *blue colouration of skin* and even cancer. Nitrate poisoning is frequent in Rajasthan due to hard and saline water.

132.(1) MRI (Magnetic Resonance Imaging) detects water because it focuses on the behaviour of Hydrogen in water molecules. This allows MRI to distinguish between water rich and water poor tissues. Hence canine teeth and scapula bone which are poor in water do not appear in MRI, whereas eyelens, ligaments and tendons are visible.

133.(3) Valium is a depressant under the class of drugs called Benzodiazepines which depress the brain activity and produces feelings of calmness, relaxation, drowsiness and deep sleep (high doses). Amphetamine is a stimulant, pethidine is an opiate narcotic that suppresses brain function and relieves physical and mental pain.

Marijuana is an hallucinogen that alters thought, feelings and perceptions.

134.(2) Each antibody molecule is composed of two identical light chains and two identical heavy chains.

The Antigen binding sites are formed by a complex of both heavy and light chains, but the stem region is formed by the heavy chains alone.

135.(2) Menstrual cycle is the set of recurring physiological changes in a females body that are under the control of reproductive hormones and are necessary for reproduction. The cycle is generally of 28 days

Release of the egg is known as ovulation and occurs at the 14th day of cycle. Endometrium regenerates within 6–10 days. It secretes glycogen rich fluid for implantation for two weeks Implantation occurs within 5–7 days of ovulation.

After ovulation that is after the 14th day the progesterone level rises.

136.(1) *Agrobacterium tumefaciens* is a remarkable species of soil dwelling bacteria that has ability to infect plant cells with a piece of DNA. When the bacterial DNA is integrated into a plant chromosome, it effectively hijacks the plants cellular machinery and uses it to ensure the proliferation of bacterial population.

137.(4) Certain substance like DDT donot break down naturally and retain its form for an intended period of time.

Osteoporosis is a disease characterized by loss in bone density

Black foot disease is a severe form of peripheral vascular disease in which the blood vessel in the lower limbs are severely damaged, resulting in progressive gangrene

Itai-Itai disease is caused due to chronic cadmium poisoning.

138.(4) When deprived of drinking water the camels allow their body temp. to rise to limit amount of water lost by sweating. It also does not produce urine but stores urea in the tissue.

139.(2) Cri du chat syndrome is caused by the deletion of information on chromosome 5. Between 1 in 20,000 to 1 in 50, 000 babies are affected. Infants with this syndrome have a distinctive cat like cry due to laryngeal deformities

140.(2) Mustard belongs to brassicaceae family characterized by 4 petals tetramerous 6 stamens (4 long - 2 short) pistil that is partitioned length wise into 2 divisions, bicarpellary (both carpels fused at the base but free above), and siliqua fruit (2 chambered dry fruit)

141.(3) When a phenotype is influenced by more than one gene, we say that the phenotype is under the control of polygenes. Total number if progeny will be 64 out of which only 2 will be like either parents so percentage will be less than 5%. The phenotype ratio will be 1 : 6 : 15 : 20 : 15 : 6 : 1.

142.(1) The sieve tube elements are large cylindrical cells with large pores in the cell wall at either end. They are almost entirely dead and have no organelle including nucleus. All their functions are carried out by companion cells.

143.(4) All the chromosomes condense and pairing occurs in leptotene forming homologous dyads. The synaptonemal complex begins to form in zygotene. Synapsis is complete in pachytene. In diplotene the DNA recombination is complete and synaptonemal complex starts breaking. In diakinesis the chromosomes decondense.

144.(2) Recombination between existing chromosomes produces with their own sequences, unique

sequences and many new genetic variants of a character like body size were probably generated by recombination

145.(2) Plastids are large organelles found on plants and some protists but not in animal or fungi. Chloroplasts, leucoplasts are all plastids

146.(2) Lysosomes are roughly spherical bodies bounded by a **single membrane**. They are manufactured by the Golgi apparatus. They contain over 3 dozen different hydrolytic enzymes.

147.(4) Glyoxysomes are microbodies found in seeds and possess enzymes capable of mobilizing lipids, converting them into sugars to supply energy needed during germination, hence they are found in castor endosperm.

148. (3) Niche is a term describing the relation position of a species or population in an ecosystem. It includes how a population responds to the abundance of its resources and enemies. 'Abiotic' or physical environment is also part of the niche

149. (1) Pyramid of number in grassland is always upright as the herbivores and carnivores are less than the producer. Pyramid of energy is also upright because only 10% energy transfer takes place to next level

150.(4) Even though the substrate concentration increases the velocity is decreasing thereby showing a presence of an inhibitor.

151.(2) Nephridia, malpighian tubules and urinary tubules are all excretory structures

152.(1)Fibula and phalanges.

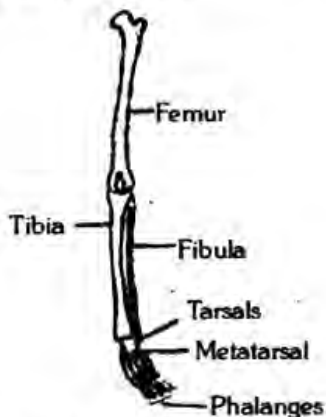

153.(2) Electroporation is a method of physically introducing DNA into a cell. In this procedure, a large electric pulse temporarily disturbs the phospholipid

bilayer, allowing molecules like DNA to pass into cell.

154. (4) Somaclonal variation has provided a source for development of variant plant lines. This appears in tissue culture raised plants. Plant tissue cultures isolated from even a single cell can show variation after repeated sub-culture. Distinct line can then be selected with their peculiar morphology and physiology. This variation can be transmitted to plants regenerated from the tissue cultures

155. (2) The growth is not directly proportional as then the graph would be a straight line. Cholesterol is essential dietary requirement as it promotes growth.

156. (3) Prosopis is a tree that grows on sandy, rocky, medium to fine-textured soil in semi-arid and arid regions (scrub). Sugar cane belongs to genus *Saccharum* which is a grass that is cultivated for sugar production.

Shorea is used as timber and is a tree belonging tropical rain forest.

Acacia is a tree particularly prevalent in arid and semi-arid and the dry sub tropical regions.

157.(4) Reverse transcriptase is a DNA polymerase that uses RNA as its template. Thus it is able to make genetic information flow in the reverse (RNA to DNA) direction instead of its normal direction (DNA → RNA)

158.(3) Gibberlin promotes the production of α -amylase, a hydrolyzing enzyme. Germinating seed cannot produce its own energy as chloroplast have not yet differentiated. The stored energy is in the form of starch (endosperm) and must be converted into a usable form. α - amylase converts starch, into simple sugars that can be used by developing embryo.

159. (2) All four belong to the phylum Arthropoda which have a stiff cuticle made largely of chitin and proteins, forming an exoskeleton. The phylum takes its name from its distinctive jointed appendages, which may be modified in a number of ways to form antennae, mouth parts and reproductive organs.

160. (1) The germ cell in the Pollen grain divides and releases two sperm cells which move down the

same pollen tube. One sperm cell fuses with the egg, producing the zygote which later develops into next generation sporophyte. The second sperm fuses with the two polar bodies located in the centre of the embryo sac, producing the nutritive triploid endosperm tissue that will provide energy for the embryos growth and development.

161.(1) Senescence is the state or process of aging. Organismal aging is generally characterized by the declining ability to respond to stress, increasing homeostatic imbalance, and increased risk of disease.

The body regulation depends on changes in gene expression that affects the systems responsible for maintenance, repair and defense responses.

162.(1) Using recombinant technology, many human genes have been cloned in *E-coli* or in yeast. This has made it possible for the first time to produce unlimited amount of human proteins *in vitro*. Cultured cells (*E-coli*, yeast, mammalian cells) transformed with the human gene are being used to manufacture Insulin for diabetics, human growth hormone, erythropoietin (EPO) for treating anaemia, etc.

163.(2) Methane a powerful green house gas is derived from sources such a rice paddies, bovine excreta, bacteria in marshes, and fossil fuel production. Though the methane content in exhaust has been reduced by multi-point fuel injection automobile exhaust does not have a major proportion in global methane.

164.(2) Particulate matter is a collective term used for small solid and /or liquid particles found in atmosphere. Particulate matter may be created by natural processes (e. g. pollen bacteria, viruses, fungi, mold etc.) or through human activities including diesel trucks, power plants, wood stores and industrial processes.

Catalytic converters are designed to reduce the emission of harmful gases carbon monoxide (CO), Hydrocarbons or volatile organic compounds (VOC) and Nitrogen oxides (NO and NO₂ together called NO_x). Three way catalytic converts control the emission of above three major harmful exhausts.

165.(4) Interferons are natural proteins that belong to family of cytokines (messenger proteins) that play a role in immune system. Interferons are secreted by infected cells and help protect other cells from infection. The three major classes are Alpha, Beta, and Gamma. They stimulate both macrophages and NK cells. Interferon Gamma is involved in the regulation of the Immune and inflammatory response.

166.(1) An organ transplant is the transfer of organ or tissue including bone marrow from a living person or a cadaver to another living person to replace his non-functioning organ. Immuno suppressants dampen the immune response or restore immune balance among immune system components. They are primarily used to prevent allograft rejection after organ transplantation. Foreign blood or tissue can trigger a blood transfusion reaction or transplant rejection. To help prevent this donor and recipient tissue is compared before transplantation, the match is usually not perfect. No two people (except identical twins) have identical tissue antigens. Suppressing the immune response can treat and prevent transplant rejection.

167.(3) Haemophilia is a blood clotting disorder caused by a mutation of factor VIII gene, leading to a deficiency of factor VIII. It is the most common Haemophilia. Inheritance is X linked hence, males are affected while females are carriers and very rarely display a mild phenotype. It is characterized by prolonged clotting time, decreased formation of thromboplastin and diminished conversion of prothrombin.

Prothrombin producing platelets are not affected in this disease.

168.(3) A humans sex is determined by the sperm (male) gamete. The egg gamete mother cell is said to be homogametic, because all its cells possess the XX sex chromosomes. Sperm gametes are heterogametic because around half the them contain the X chromosome and others possess the Y chromosome to compliment the first X chromosome. In light of this there are two possibilities that can occur during fertilization between male and female gametes, XX and XY. Since sperm are the variable factor they can determine (i. e. which fertilizes the egg) they are responsible for determining sex.

Thus sex in humans is not a polygenic trait but a monogenic. Polygenic traits are determined by more than one pair of genes.

169.(3) Mitochondria and chloroplast are unique among the constituents of eukaryotic cells as they are semiautonomous organelles that contain their own genetic machinery. As such they operate under the dual genetic control of nuclear DNA (nDNA) and mitochondria DNA. Both mitochondria and chloroplast have protein synthesising machinery.

170. (1) The DNA is situated in the nucleus, organized into chromosomes. Every cell must contain the genetic information and the DNA is therefore replicated before the cell divides. When proteins are needed, the corresponding genes are transcribed into RNA (transcription). The RNA is first processed so that non-coding parts are removed (processing) and is then transported out of the nucleus as mRNA in the cytoplasm where amino acids and protein synthesis machinery is present (Ribosomes). Proteins are built based upon the code in the RNA (translation).

171.(3) Fungi are a diverse group of eukaryotic organisms which lack chloroplast and are unable to perform photosynthesis to produce their own organic molecules.

Thus fungi must obtain preformed organic molecules from the environment. Fungal cell walls contain chitin a complex carbohydrate that is very resistant to degradation by other microorganisms. In addition, fungi secrete digestive enzymes into the environment to breakdown organic molecules, and then the fungi absorb these products.

Most fungi consist of thread like filaments referred to as vegetative hyphae. These hyphae elongate into food source and absorb nutrients from the environment. The dispersal of fungal spores which are produced on reproductive hyphae enables a fungus to quickly spread through environment and utilize resources when they are abundant.

172. (1) Normal carbon assimilation is known as the C3 pathway in which six turns are necessary for the formation of one glucose molecule. A simple equation is: $\text{CO}_2 + \text{RuBP} \rightarrow 2\text{PGA}$. Essentially, a 5 carbon and 1 carbon are converted into two 3 carbon molecules (PGA) which are later combined

to form glucose. However this is an inefficient process for two reasons: (1) there are low levels of carbon in the atmosphere, and (2) rubisco (RuBP) has a low affinity for CO_2 . In response, plants produce high levels of RuBP. However, when these high concentrations come into contact with O_2 , a major bi-product of photosynthesis, oxidation occurs and the process is further reduced in efficiency. So as O_2 levels increase, carbon assimilation rates are decreased. Plants generally compensate for this by keeping their stomatas open during the day

The evolution of an additional step in carbon assimilation pathway is what distinguishes C4 plants from C3 plants. C4 plants have an extra step which allows spatial separation within the leaf. In these plants, CO_2 is sequestered into the bundle sheath cells where a new molecule, (Phosphoenol pyruvate) PEP carboxylase, resides and has a high affinity for CO_2 . Also, bundle sheath cells are smaller than mesophyll cells, resulting in a higher concentration of CO_2 , simply by virtue of transport from mesophyll to bundle sheath. PEP carboxylase combines PEP with CO_2 and results in OAA (oxaloacetate) which then proceeds in the remainder of the dark reactions. Essentially, C4 plants concentrate levels of CO_2 and keep RuBP away from O_2 , both of which make photosynthesis a more efficient process

173. (2) the ozone layer in the stratosphere keeps 95-99% of the sun's ultraviolet radiation from striking the earth. A number of consequences can result from increased levels of UV (ultraviolet radiation) striking the earth, including: genetic damage, eye damage and damage to marine life. Increased UV radiation in the lower atmosphere, called the troposphere, can result in increased amounts of photochemical smog. Photochemical smog is already a health hazard in many of the world's largest cities.

Global warming is a term used to describe the increase over time of the average temperature of the Earth's atmosphere and oceans. "most of the warming observed over the last 50 years is attributable to human activities", most prominently the emission of greenhouse gases such as carbon dioxide (CO_2)

Greenhouse gases (GHG) are gaseous components of the atmosphere that contribute to the greenhouse effect. The major natural greenhouse gases are water vapor, which causes about 36-70% of the greenhouse effect on Earth (not including clouds); carbon dioxide, which causes between 9-26%; and ozone, which causes between 3-7%

Minor greenhouse gases include, but are not limited to: methane, nitrous oxide, sulfur hexafluoride, and chlorofluorocarbons

- 174.** (4) More than 100 cases of true tail has been reported in humans. The true atavistic tail of human results from incomplete regression of the most distal end of the normal embryonic tail found in the developing human foetus. This is the case of atavism. Hence the gene for tail formation is still present in human. As the human embryo still shows presence of a tail.

The theory of continuity of germ plasma was given by Weismann. In his view the somaplasm (body cell) simply provide the housing for the germplasm (gamete producing cells), seeing to it that the germplasm is protected, nourished and conveyed to the germplasm of the opposite sex to create the next generation.

- 175.** (2) Comparative biochemistry is the field of biology that deals with comparing similarities among different species DNA and proteins produced from the DNA. The more similar two different species DNA is, the closer the evolutionary link, and the more recent the two species shared a common ancestor. This is evidenced in the fact that humans and apes have more than 99% similar DNA sequences!

The genetic code is a set of rules, which maps DNA sequences to proteins in the living cell, and is employed in the process of protein synthesis. Nearly all living things use the same genetic code, called the standard genetic code, although a few organisms use minor variations of the standard code.

- 176.** (1). Darwin's finches share similar size, coloration, and habits. Their salient difference is in the size and shape of their beak. However, beak shapes can be very variable, and the size and shape in one individual can overlap into the range of another species

Darwin's finches are an excellent example of the way in which species' gene pools have adapted in order for long term survival via their offspring

Indeed, the Galapagos have been called a living laboratory where speciation can be seen at work. A few million years ago, one species of finch migrated to the rocky Galapagos from the mainland of Central or South America. From this one migrant species would come many -- at least 13 species of finch evolving from the single ancestor.

This process in which one species gives rise to multiple species that exploit different niches is called adaptive radiation. The ecological niches exert the selection pressures that push the populations in various directions. On various islands, finch species have become adapted for different diets: seeds, insects, flowers, the blood of seabirds, and leaves

- 177.** (3) The CO_2 compensation point is the CO_2 concentration at which Net Photosynthesis for a leaf is zero. (This is the point where gross photosynthetic rate equals respiration). It is reached when the level of CO_2 in atmosphere is LESS than that required to go above CO_2 compensation Point. Similarly, the light compensation point is the light level at which Net Photosynthesis for a leaf is zero although CO_2 is in abundance.

- 178.** (2) France and Germany are developed countries. The age-sex structure of the developed world gives steeper pyramid which represents a nearly stable population

In developing countries like Sudan, India, Pakistan, Bangladesh etc., the population is growing rapidly hence giving a less steep age-sex pyramid as it has a much larger number of young people.

- 179.** (2) The Class Mammalia includes about 5000 species placed in 26 orders

All mammals share at least three characteristics not found in other animals: 3 middle ear bones, hair, and the production of milk by modified sweat glands called mammary glands. The three middle ear bones, the malleus, incus, and stapes (more commonly referred to as the hammer, anvil, and stirrup) function in the transmission of vibrations from the tympanic membrane (eardrum) to the inner ear. The malleus and incus are derived from

bones present in the lower jaw of mammalian ancestors. Mammalian hair is present in all mammals at some point in their development. Hair has several functions, including insulation, color patterning, and aiding in the sense of touch. All female mammals produce milk from their mammary glands in order to nourish newborn offspring.

180.(1). Plant transformation mediated by the soil plant pathogen *Agrobacterium tumefaciens* has become the most used method for plant transformation. *A. tumefaciens* naturally infects the wound sites in dicotyledonous plant causing the formation of the crown gall tumours.

A. tumefaciens is capable to transfer a particular DNA segment (T-DNA) of the tumour-inducing (Ti)

plasmid into the nucleus of infected cells where it is subsequently stable integrated into the host genome and transcribed, causing the crown gall disease

The tumour formation is a transformation process of plant cells resulted from transfer and integration of T-DNA and the subsequent expression of T-DNA genes. Secondly, the T-DNA genes are transcribed only in plant cells and do not play any role during the transfer process. Thirdly, any foreign DNA placed between the T-DNA borders can be transferred to plant cell, no matter where it comes from. These well-established facts, allowed the construction of the first vector and bacterial strain systems for plant transformation